

**SHEAFFER'S  
SERVICE MANUAL**

**SECTION**

**A**

BE ACCEPTED-FC  
of equal value.  
of parts.

Many service stations return parts classified as defective they are found damaged and not defective. Therefore, as stated in the parts believed to be defective must be confirmed by our inspection before placement on a no-charge basis.

#### SUGGESTIONS FOR REDUCING PARTS COST.

When returning parts for exchange, please make sure that these parts are complete. On parts received with missing parts, the cost of the missing part will be assessed in lieu of the parts exchange charge. By missing parts, we mean that if a barrel is returned with the lever missing, you will be charged the cost of the missing lever.

Quite often, we find that parts are returned for exchange which require only a replacement of a small part to put them in first-class condition. An example of this would be a Touchdown or Snorkel model barrel being returned for exchange when only a new compression gasket or plunger tube is required. In this case, we would suggest that you return only the plunger tube or compression gasket for exchange. This would save you several dollars over a period of time, e.g. if you were to return ten barrels to us for exchange and seven of them were found in need of a new compression gasket, you would save \$2.66. The savings would be the difference between the exchange cost of compression gaskets and barrels. Another example would be the return of ten barrels for exchange and five were found in need of new plunger tubes, you would realize a savings of \$1.25 by exchanging plunger tubes rather than the entire barrel. Also, do not overlook the exchange of plungers or washers on pens containing the plunger type filling mechanism. A close inspection of these parts before their return may reveal that they can be serviced at less cost to you. Remember, the less your parts cost, the higher the profit.

The new mechanism replacement tool set for retractable ballpoint pens will enable you to replace retractable mechanisms. This will eliminate the return of caps for replacement as you should only find it necessary to return the old mechanisms for new ones.

Many service stations return used plastic non-Lifetime caps to be exchanged. As you will note in the parts exchange policy, there is no exchange policy on these plastic caps. Therefore, it is not necessary they be returned along with your parts exchanges, unless you are returning them for identification purposes. Only the metal caps and caps containing 14K gold trim carry an exchange charge.

In view of the pen substitution policy, you can exchange Lifetime parts for new Touchdown parts which will enable you to furnish your customer with a new Touchdown pen in exchange for his Lifetime pen. On the exchange of caps and barrels, you will receive black parts unless you specify the color desired on the job envelopes.

Always recommend Skrip to your customers as it has been especially developed for Sheaffer pens. Certain types of fast drying ink contains some chemical properties which cause deterioration of the inner parts of most fountain pens.

## EXPLANATION OF SERVICE DATA

The purpose of the following material is to:

1. Help you identify Sheaffer pens which you receive from your customers for repairs. (You should know the trade name of the model, correct color designation, retail price, and factory symbol number.)
2. Help you order from the factory the correct repair parts you need.
3. Help you analyze our repair invoices (which lists pens according to factory symbol number) and to identify repaired pens which are returned to you from the factory.

Section B includes sheet which show drawings of Touchdown & Snorkel models manufactured by this company, with the correct symbol number, trade name, and price under each model.

Here is how it works: When you have a Sheaffer pen you cannot identify, leaf through the illustrated sheets, (identification charts) in section B until you find a drawing of a pen that is the same shape and size as the pen you cannot identify. Then refer to the "Distinguishing marks" listed below the illustrated pen, and compare each feature of the pen you have with the distinguishing marks listed. When you find the column listing the distinguishing marks that exactly correspond with your pen, the correct symbol number, trade name, and retail price will be shown at the top of that page.

WHEN YOU HAVE IDENTIFIED A PARTICULAR MODEL FROM THE IDENTIFICATION CHART, FOLLOW THE COLUMN ON DOWN AND YOU WILL FIND THE SYMBOL NUMBER OF THE VARIOUS PARTS USED IN THIS PARTICULAR PEN. PRICES ON INDIVIDUAL PARTS AND EXCHANGE CHARGES ON THESE PARTS ARE ALSO SHOWN.

Important: All symbol numbers shown are for plain black pens. Each color, except black is designated by a letter in front of the symbol number. The absence of a prefix letter indicates that the pen is black. The "Color Code Chart" on page A4 will show which color each letter designates.

PENCILS: The same color letters apply to pencils, except that black pencils are indicated by the letter "L", while black PENS are indicated by the absence of any prefix letter. When ordering parts for a pencil, it will be simpler to associate the pencil with a matching pen in your order. (Example: "Mechanism for pencil that matches 121S pen.")

If there are any questions regarding any of this material, or other service matters, write direct to the Service Correspondence Division.

SHEAFFERS SERVICE MANUAL

INDEX

	<u>PAGE NO.</u>
SECTION A	
Foreward. . . . .	A1-2
Service Data. . . . .	A3-4
Color and Symbol Explanation Pages. . . . .	A5-6
Pen Parts Nomenclature Pages	
Regular and T.M. Touchdown . . . . .	A7
Snorkel. . . . .	A8
<i>IMPERIAL B62.</i>	
SECTION B	
<i>COMPACT #2 B61</i>	
Pen Identification Pages	
Regular Touchdown. . . . .	B1-17
T.M. Touchdown . . . . .	B18-22
TipDip . . . . .	B23-26
Snorkel. . . . .	B27-41
<i>PFM PENS</i>	
<i>TARGET PEN</i>	
<i>5100, 8175 2195 CF PEN</i>	
<i>B45, B46, B53</i>	
SECTION C	
Procedure for Repair Pages	
Regular and T.M. Touchdown . . . . .	C1-2
Snorkel. . . . .	C3-4
Points . . . . .	C5-8
Plastic Cap. . . . .	C9
Metal Cap. . . . .	C10
SECTION D	
Miscellaneous	
Pencil and Pencil Parts Price List . . . . .	D1
Ballpoint and Ballpoint Parts Price List . . . . .	D2
Tools for Touchdown and Snorkel Repair . . . . .	D3-8
Parts Exchange Policy. . . . .	D9-12
<i>PFM PENCIL PARTS &amp; TARGET.</i>	
<i>D1-A</i>	
<i>1.49, 1.95, 2.49 BALL PEN PARTS</i>	
<i>D7-A</i>	

## YOUR REPAIR SERVICE DEPARTMENT

There is a very definite relationship between selling merchandise and servicing that same merchandise. In a great many instances, a sale will actually depend on your ability to offer service on the product and such is very true in selling pens and pencils.

For this reason, we maintain here at Sheaffers a very efficient and up-to-date Service Department and parts exchange department, to handle repairs, exchanges and adjustments on all Sheaffer merchandise. Your Service Department as well as ours is operated for the benefit of all Sheaffer users, who are confident that should some adjustment be necessary on their Sheaffer pen or pencil, such repairs will be handled for them by you or by our Service Department within a very reasonable length of time and for a nominal charge.

### PROPER INSTRUCTIONS

In order to insure a successful operation and to offer you the best and prompt service, we must have the full co-operation of every one of our authorized service stations.

In returning parts for exchange, please be sure that the authorized label appears upon the outside of the parcel. This will insure routing of the parcel to parts exchange department for prompt handling.

The method of returning parts for exchange that has proved most satisfactory is to return the parts in envelopes separated by type along with complete listing sheet of all parts to be exchanged. By separated we mean that the parts should be broken down so that parts of one type or similar type are included in each separate envelope. As an example, barrels and barrel shells in one envelope, feeds and point holders in another envelope and points of different style and gradations in another envelope etc. The parts enclosed in each envelope should be listed on the outside. Also, you should indicate on the envelope what is wanted in exchange if different from the parts returned, such as the feeds desired, color of barrels or caps etc. Envelopes containing points for exchange should indicate the point gradation or classification of the points desired in return.

The listing sheet which is to accompany the return of the parts for exchange should be made out in duplicate in order to provide one copy for your records and one copy for our records. This listing sheet should bear an order number which would make it much easier for us to check on any exchange in question or one which you may not have received and you may be tracing. The parts should be itemized in the following order on the listing sheet: pen points, small parts, barrels and barrel shells and caps.

Complete pens being returned for repair should be sent under separate cover and not with parts being returned for exchange. Should complete pens be returned along with the parts, this would only delay the handling of the parts exchange as well as the repair of the pens. Another important fact we feel necessary to mention is that the number of items returned for repair should be a maximum of five to a parcel. This would insure more prompt handling. Should more than five pens be returned for repair, the possibility that one item may be held up by the repair department, then the entire shipment would be delayed. In returning the repaired merchandise...

Oftén times, you find  
department and in this case  
ng these parts rec...

## SHEAFFER'S COLOR CODE

Colors of all merchandise manufactured up to 1956 are designated by a letter in the symbol. (The only exception is on black pens where the omission of a letter indicates black.)

### Primary Line Colors

<u>Letter</u>	<u>Color</u>	<u>Letter</u>	<u>Color</u>
C	Striated Brown	L	Black
E	Striated Green	N	Burgundy (Old)
P	Striated Grey	Q	Pastel Grey
S	Striated Maroon	V	Pastel Blue
B	Burnt Umber Brown	W	Persian Blue
J	Evergreen Green	Y	(Pastel Green/

EXAMPLE: Y121SK - Pastel Green Snorkel Pen LT<sub>4</sub> - Black Thin Pencil  
 N121S - Burgundy TM Touchdown Pen HN<sub>4</sub> - Burgundy Retractable Ballpoint

### Non Primary Line Colors

<u>Letter</u>	<u>Color</u>	<u>Letter</u>	<u>Color</u>
D	Light Blue	T	Blue
P	Light Grey	R	Red
G	Green	U	Coral
M	Yellow	Z	Dusty Rose
		W	White Pearl

EXAMPLE: AHP195 - Grey Retractable T195-2 Blue Lever Pen

New Colors introduced during and after 1956 will be designated by numbers.

1 Golden Glow Yellow	11 Black	25 Burgundy (new)
2 Peacock Blue	12 Bermuda Blue	26 Anodized Gold
3 Diamond Blue	13 Nocturne or Navy Blue	27 Anodized Copper
4 Spring Mist Green	14 Gold	28 Anodized Blue
5 Colonial White	15 Stainless Steel	29 Anodized Pink
6 Berkshire Green	16 Silver (anodized)	30 Anodized Green
7 Buckskin Tan	17 Fern Green	31 Telephone Green
8 Mandarin Orange	18 Periwinkle Blue	32 " Blue
9 Fiesta Red	19 Vermilion	33 " Beige
10 Platinum Grey	20 Sage Green	34 " Red
	23 Dark Bluish Grey	35 " Ivory

EXAMPLE: 9-121SK - Fiesta Red Snorkel Pen

If the item is two-tone the first letter will denote the cap color, and the second the barrel color.

EXAMPLE: 11C9 - Cartridge Pen with a black cap and a red barrel.

## IDENTIFICATION DATA

To help you in identification of our merchandise and parts, listed below are key letters and numbers used in addition to the color symbols shown on page #A4 on all models introduced prior to January 1957.

### PENS

#### Point Size:

23, 3, 33) Conventional  
5, 52 ) Points  
73, 74, 8)  
  
92, 93 ) Triumph  
12, 13 ) Points

#### Styles:

T - Lever Fill  
W - Vac Fill, Long  
WS - Vac Fill, Short  
S - Touchdown, Long  
SM - Touchdown, Short

#### Styles cont'd:

SK - Snorkel  
F - Tip Fill  
C - Cartridge Fill  
D - Desk Pen

### PENCILS

#### Styles:

H-Regular Balance, Long  
E-Regular Utility  
M-Regular Balance, Short  
T-Thin Pencil  
D-Desk Pencil

#### Band Sizes:

#2 - 3/16"  
#3 - Bead Band  
#4 - 3/8"  
#5 - 1/8"

#### Band Sizes cont'd:

#6 - Gold Cap  
#6X - Stainless Steel Cap  
#7 - 1/4"

### BALLPOINTS

Prefix AH or H - Retractable Model  
Prefix R - Cap Model Primary Line  
Suffix B - Cap Model Non Primary Line

#### SPECIAL SYMBOLS - Used on all Items

Z - Solid Gold  
A - Autograph  
X - Chrome  
Y - Gold Filled  
XC - Stainless Steel Chased Cap

On all new models introduced after January 1957, we will adopt a new symboling system as follows:

1. The first letter in each symbol will be the product identification. As an example, a symbol starting with the letter "A" will always be a pen number, "B" ballpoint, and "C" pencil.
2. The first number in each symbol will be the color code. As an example, "eleven" written 11 will always be black.
3. The next letter in each symbol will be the type. As an example "K" will indicate Snorkel type pen or "R" will indicate retractable push button type ballpoint, or "T" would indicate thin balance pencil.
4. The next number in each symbol will indicate the size of nib. As an example, in pens "5" will indicate the gold sheath type point which was previously called our #12. (We intend to drop the old numbers and use only the "Official Pen Point Identification Code" numbers, which are on the points of our pens.) Point code identity discontinued in mid-1958.
5. The last letter would indicate trim. As an example "X" would indicate chrome band on pen, ballpoint or pencil.

See page A6 for complete list.



SYMBOL SYSTEM  
PRODUCT

P E N S - A

B A L L P O I N T S - B

P E N C I L S - C

COLOR CODE

(Same for Pens, Pencils, and Ballpoints)  
See Page A4

P E N S :

Leverfil - T  
Tip fil - F  
Cartridge - C  
Touchdown - S

Snorkel - K  
Desk - D

B A L L P O I N T S :

Retractable - R  
Cap Model Retractable - C  
Desk - D  
Sliding Spring - H

Reminder Clip - J  
Ratchet - P

NUMBER

PEN POINT CODE:

Code etching on points discontinued mid-1958  
Steel (Fineline) - 0  
Steel - Regular - 1  
Gold (Old #5) Regular - 2  
Gold Regular (#23) - 23  
Gold Regular (Old #74) - 3  
Palladium Sheath (Old #13) - 4  
Gold Sheath (Old #12) - 5  
Palladium Regular (Old #6) - 6  
Gold Regular (Old #52) - 7  
Palladium Short Sheath (Old 7) - 8  
9.2K Gold Short Sheath (Old 10) - 9  
Palladium Silver-PFM Inlaid - 14  
14K PFM - Inlaid - 15  
Compact - Inlaid 14K - 21  
Compact - Inlaid Pal. Silver - 20  
Imperial - Inlaid 14K - 17  
Hooded PEP Niblet - 18  
ST Steel Diamond-shaped - 30  
14K Diamond-shaped - 31

TRIM LETTER

PEN:

Gold Cap - Y  
Chrome Cap - I  
14K Gold - Z  
Chrome Band - X  
Aluminum Cap (Anodized)-V  
Signature - S  
Stainless Steel Cap - W  
Autograph - A  
Lady Sheaffer-P1, P2, etc.

BALLPOINT:

Gold Cap - Y  
Chrome Cap - I  
14K Gold - Z  
Chrome Band - X  
Aluminum Cap (Anodized)-V  
Signature Cap - S  
Stainless Steel - W  
Autograph - A  
Octagonal - O

P E N C I L S :

Regular Balance (.375) - H  
Thin Balance (.311) - T  
Thin Utility (.311) -  
Regular Utility (White Center  
(.350) - E

Desk D  
Advertising A  
PEP (Flat & Slant) F  
PFM M

PENCILS:

Cadet - 1  
Craftsman - 2  
Sovereign - 3  
Valiant - Statesman - 4  
Clipper - Sentinel - 5  
Crest - 6  
Admiral - Special - 7  
(New) (Craftsman) - 8  
Triumph - 9  
(New) Special - 10  
Signature - 4 Sig.  
Autograph - 4 Auto.

PENCILS:

Gold Cap - Y  
Chrome Cap - I  
14K Gold - Z  
Chrome Band - X  
Aluminum Cap - V  
Signature Cap - S  
Stainless Steel - W  
Autograph Cap - A  
Lady Sheaffer - P1, P2, Etc.

The symbol system in use prior to 1957 will be used on models introduced prior to January 1957.

Simulated Leather - H

NOMENCLATURE OF TOUCHDOWN PEN PARTS--REGULAR AND TM

 - - - - - POINT

(See individual pen pages for part prices and part exchange prices.)

 - - - - - TRIUMPH NIB UNIT

 - - - - - FEED

 - - - - - GRIPPING SECTION

 - - - - - THREAD RING

 - - SAC

 - - - - - BARREL REINFORCING BAND

 - BARREL SHELL

ALL NEW BLS. COME WITH O RING ASSEMB.

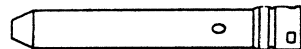
 - - SAC PROTECTOR TUBE

 - - - - - COMPRESSION GASKET

 - - - - - SCREW

 - - - - - PLUNGER TUBE GASKET

 - - PLUNGER TUBE

 - - - - - PLUNGER KNOB

NOTE: Complete barrel assembly includes: Plunger Knob, Barrel Shell, Compression Gasket, Reinforcing Band, Screw, Plunger Tube Gasket and Plunger tube.

**SECTION**  
**C**

TOUCHDOWN MODEL PENS

TO IDENTIFY THE TOUCHDOWN MODEL PENS: UNSCREW PLUNGER KNOB. PULL PLUNGER OUT. THE LARGE PLUNGER TUBE IS POSITIVE IDENTIFICATION.

DISMANTLE

OPERATIONS IN SEQUENCE

TOOLS AND METHODS USED

- |  |  |
|--|--|
| #1 Remove Point Unit -----   | Place point in 120 degree water for 10 seconds to soften sealing compound. Place thumb on feed and forefinger on point and unscrew, keeping feed and point in line. If regular style point remove point and feed from barrel end as on page C2A. |
| #2 Remove Gripping Section, Protector Tube and Sac From Barrel ----- | Use Rubber<br>Place rubber on Gripping Section and unscrew.  |
| #3 Remove Protector Tube and Sac From Gripping Section -----         | Grip Section tightly in one hand. With other hand grip protector tube near large end and rock off. Do not twist. Sac can now be removed.   |
| #4 Remove Plunger Tube -----   | Small long shank screw Driver. Unscrew barrel cap. Place screw driver in barrel and through plunger tube until it contacts screw in Plunger Knob. Unscrew barrel cap. Plunger tube can now be removed from barrel.                               |
| #5 Remove Compression Gasket -----                                   | Use Dull Pin or bend & file a small hook in paper clip. Place point of dull pin gently behind Gasket and gently remove.  |

After dismantling the pen, all parts should be thoroughly cleaned and inspected and all worn, broken, or wrong parts should be replaced.

ASSEMBLE

- |                                     |   |
|-------------------------------------|---|
| #1 Replace Compression Gasket ----- | Compression Gasket Positioning tool. See Page D3. |
|-------------------------------------|---|

- #2 Replace Plunger Tube ----- Small long shank screwdriver.  
Place screw on screwdriver.  
Place Plunger Tube Gasket on screw  
and insert into plunger tube,  
insert plunger tube into barrel,  
place shake-proof washer on  
screw and screw plunger knob on  
firmly. A drop or two of #30  
motor oil can be placed on the  
plunger tube to make it work more  
smoothly. WARNING!!  
DO NOT USE CASTOR OIL!!!
- #3 Replace Sac on Gripping ----- Use Sac Spreader and Shellac.  
Section. Be sure and use  
proper sac Use shellac freely on Gripping  
Section as this type pen requires  
a tighter seal than other types.  
Allow to dry a few seconds before  
applying sac. Place proper sac  
on spreader. Insert Gripping  
Section into spread lip of sac.  
Hold sac in place with forefinger.  
Remove sac spreader. Straighten  
sac.
- #4 Replace Protector Tube ----- Immediately place protector tube  
over Sac. Push on Gripping Section  
until tube touches threaded shoulder  
on Gripping Section.
- #5 Replace Gripping Section, Sac ----- Screw Gripping Section into barrel.  
and Protector Tube Use a small amount of warm point  
sealing compound on threads.
- #6 Replace and seal Point Unit ----- Use rubber and sealing compound.  
Start point unit into barrel end  
and spread warm sealing compound  
evenly over exposed threads. Grip  
feed and point firmly with thumb  
on feed and forefinger on point  
and tighten firmly. Clean off  
excess sealing compound with  
gasoline.

NOTE: If any point or triumph point unit repair is needed, refer to pages  
C5 - C8.

## DISMANTLE

### OPERATIONS IN SEQUENCE

### TOOLS AND METHODS USED

- #1 Remove Section Feed and Nib from Barrel. ----- Use padded mouth section pliers. Place pliers around section and unscrew.
- #2 Remove Feed and Nib from Section ----- Use bench block, feed punch, and hammer. Place nib and feed into proper hole in block, and place punch over insert of feed and drive out with hammer.

## ASSEMBLE

- #1 Push Feed and Nib into Section ----- Use nib pushing pliers, pushing gauge, nib gauge chart, and hammer. Place nib in right position on feed and start into section. Gauge and determine depth nib should be pushed, and place to that depth in pliers. Then rest pliers on table and drive section over nib and feed.
- #2 Replace the Assembled Section, feed, and nib, in barrel. ----- Use padded mouth section pliers. Start section into barrel, making sure plunger is retracted, and tighten with pliers.

NOTE--These are instructions taken from Page 45 of the old repair manual.

INSTRUCTIONS FOR DISMANTLING THE SNORKEL PEN

1. Extend plunger tube and unscrew the Gripping Section which removes the entire writing unit.
2. Remove the sac protector tube assembly by pulling it out of the Gripping Section assembly.
3. Unscrew the point unit from the Gripping Section.
4. Remove the point holder gasket from the point end of the Gripping Section.
5. Remove propelling spring by turning barrel on end and pumping plunger tube.
6. Grasp filler tube near sac protector bushing rocking back and forth gently and at the same time pulling out.  
CAUTION - Be certain to handle the filler tube with extreme care as damage to this part will cause malfunction of the pen.
7. With long shank screwdriver, remove plunger tube by turning screw which holds the plunger knob on the threaded plunger tube. Gasket seated atop plunger tube may or may not come out.
8. Remove compression gasket ("O" ring).

INSTRUCTIONS FOR ASSEMBLING SNORKEL PEN

1. Replace compression gasket ("O" Ring).
2. Replace threaded plunger tube in barrel. If necessary to replace gasket, place it atop plunger tube. Then put screw on long shank screwdriver, inserting into and through the plunger tube and tightening into plunger knob.
3. Enlarge the end coil of the propelling spring and place the spring, enlarged coil first, around the threaded plunger tube in the barrel.
4. Place the end of the sac protector assembly containing the rubber bushing into water at least 180° F so that the water completely covers the four splines. Hold the assembly in this position for approximately two minutes to allow the rubber bushing to be heated, then remove and insert the filler tube into the sac protector assembly bushing. Dry the assembly thoroughly with a cloth.
5. Seat point holder gasket in point end of Gripping Section.
6. Screw nib unit into Gripping Section. Sealing compound is not needed as the point holder gasket completes the seal.
7. Lubricate the filler tube with Glycerine (#94) and insert through the hole in the point holder gasket. Make sure the sac protector tube assembly is assembled with the large groove (present on the older models only) lined up correctly with the large groove slot in the gripping section. It is very important that the protector tube be properly fitted in the gripping section and moves back and forth easily requiring very little force.
8. Place a small amount of shellac (#71) on threads of gripping section and screw the writing unit into the end of the barrel with the plunger extended.
9. Depress the plunger and retract filler tube by turning to the right.

Check the position of the filler tube as follows:

- (A) The filler tube should be turned so that its slope meets the slope of the feed (Triumph point). The fissure of the filler tube should line up with the fissure in the feed. If it does not align correctly, extend the filler tube and realign.
- (B) The slope of the filler tube should be flush with the contour of the feed; neither extended nor recessed. If it is not flush, remove the barrel and adjust the filler tube length. Do this by twisting tube sideways to loosen and then pull or push.



PROCEDURE FOR SHEAFFER PEN REPAIR

On all Sheaffer nibs and Triumph nib units the following are the operations, tools, and methods used in spacing, aligning, smoothing the nib and fitting the feed.

OPERATIONS

#1 Inspect Nib

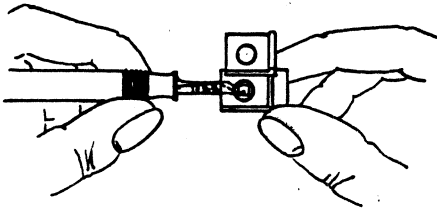

#2 Properly Space Nib

(The degree of fineness is the key to the amount of space the nib should have. The finer the nib, the narrower the spacing.)

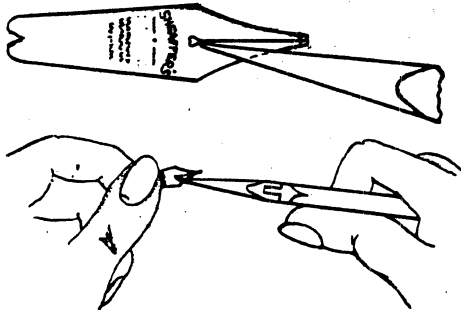

Correct position of pliers for adjusting nib.

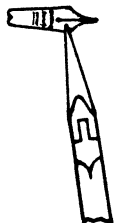

Incorrect positions of pliers for adjusting nib.

TOOLS AND METHODS

Use magnifying glass.

Place nib against bottom of glass so that it shows through the opening. Examine the iridium, determine the degree of fineness.

See illustration at left.

Use nib pliers.

Points should always be spaced far enough apart so light can be seen through entire length of the slit. Points that do not have enough space are adjusted by raising first one side, then the other, away from the feed or writing surface. Grasp the nib with the nib pliers and lift or spring up alternate sides. Do not make an abrupt bend in the nib. If the nib is spaced too much, reverse the process and spring sides down.

CAUTION: Keep the plier jaws away from the iridium tips or iridium will be broken off. When the adjustment is completed, the iridium tips must be exactly even on the writing surface.

#3 Aligning nib

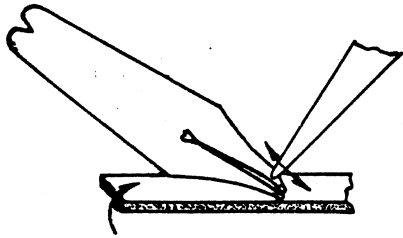

Burnishing nib which is closed at tip.



Nib correctly spaced.



Incorrect. Nib is open on the face.



Incorrect Back

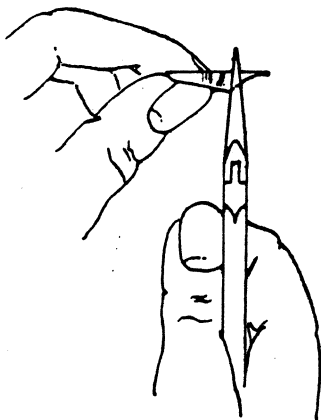

Closing nib that is open on the face.

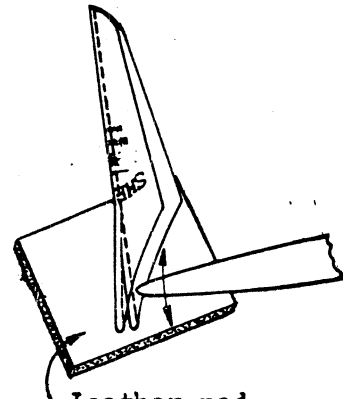

Leather pad.  
Burnishing nib which is forked at the center of slit.

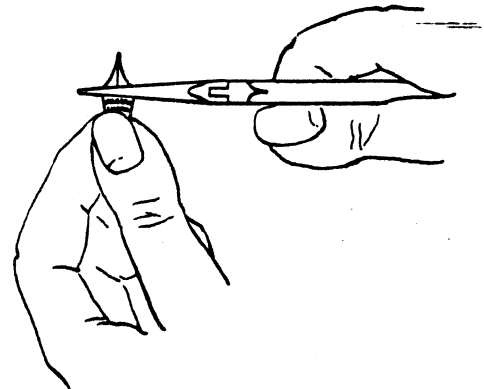

Closing nib that is open on the back.

-----  
Use nib pliers and regular burnisher. Nibs should be straightened and spacing adjusted before pen is re-assembled. Nibs which are bent in at the tip can be adjusted by burnishing the outside of the nib where the bend occurs while the iridium tip is resting on a leather pad. Nibs which are forked at the tip are treated as above except that the uppermost side is pushed away with tip of burnisher while burnishing inside of lower nib. Nibs must be spaced the same width on the face as on the back. Nibs open too wide on the face can be adjusted by springing the shoulders of point together slightly. Nibs which open wider on the back than on the face are adjusted by pressing the nib lightly across the heart with the pliers.

#### #4 Fit Feed to Nib

---

Use Alcohol lamp.

After nib and feed are pushed into section or nib unit replaced in barrel, the feed is then ready to be fit to the nib. The old style flat feed must fit tightly all along the under side of nib to insure a correct flow. The feed is made of hard rubber. By quickly passing it through a flame a number of times, the rubber absorbs heat and becomes pliable. The feed, when pliable, is molded against the nib by pressing it with forefinger. When feed has been molded to nib, dip it in water. This cools feed causing it to retain its molded form. Use care to keep the section and barrel from heat as it is extremely inflammable. The new style streamlined or "C" feed is pushed and fit in the same manner as the regular flat comb feed. This type feed requires heat and pressure only at the tip ends of feed beyond combs, as do the feeds in the Triumph nib units. Take the magnifying glass and look through the heart pierce of point. Inspect narrow ink channel in feed. After fitting feed against nib, inspect the ink slot again to see that the slot has not been closed. Closing very slightly will do no harm, but if it is closed more than half way, the section should be removed and feed and nib driven out. The ink slot then may be opened by heating feed, after which it may again be assembled.

#5 Smooth Nib

CAUTION: Do not smooth nibs unless they need it. Tips must be even on writing surface before smoothing.

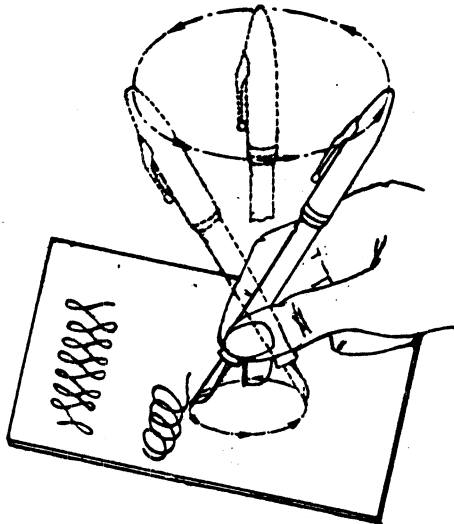

-----  
Use 4/0 smoothing paper and jewelers rouge.

If tips are even and nib scratches, the iridium may have a sharp or rough spot. This is removed on a special grade of fine smoothing paper. This paper should be placed on a firm smooth surface and a light coat of rouge rubbed over it to reduce the cutting power and to polish the iridium. To smooth nib, hold pen in a writing position and slowly move it in small circles. Finish up by writing continuous figure 8's. As the nib is moved over the paper, the position of pen should be changed continuously so a flat face will not be worn on nib tip. Use only moderate pressure and finger movement in making small circles and figure 8's. Care and skill must be exercised or more harm than good will be done. Never rub the nib on a stone or rough abrasive of any kind. The iridium must have a very smooth, mirror-like finish and any scratch or rough spot will be noticed when nib is used.

See illustration opposite.

**\*\*PROCEDURE FOR REPAIR OF SHEAFFER POSTWAR PLASTIC CAPS WITH METAL THREAD SLEEVES\*\***

**DISMANTLE**

**OPERATION IN SEQUENCE**

-----

**TOOLS AND METHODS USED**

#1 Break Band Off Cap

-----

Cutting pliers.  
Grip one side of band with cutting pliers and bend cap down until band breaks off, being careful not to damage the plastic.

#2 Pick Sleeve Out of Cap

-----

Regular burnisher and needle nose pliers.  
Pick or push sleeve toward center of cap with burnisher until needle nose pliers can be inserted between sleeve and plastic cap. Again being careful not to damage plastic. Grip sleeve with pliers and twist out.

Caution: Use only ARABOL CEMENT FOR CEMENTING SLEEVES IN CAP.

**REASSEMBLE**

Select proper sleeve and band.

#1 Cement Sleeve and Band in Cap

-----

Arabol cement.  
Spread plenty of Arabol cement evenly on thread sleeve. Push into cap as far as possible.

#2 Wipe Excess Cement off Cap

-----

With a rag moistened in water wipe until all cement is removed from cap.

**NOTE:** These caps should be allowed to dry at least 12 hours after cementing.

**\*\* PROCEDURE FOR REPAIR OF SHEAFFER METAL CAPS WITH METAL THREAD SLEEVES \*\***

**DISMANTLE**

**OPERATIONS IN SEQUENCE**

**TOOLS AND METHODS USED**

#1 Remove Thread Sleeve

-----  
Thin sharp pointed tool.  
Needle nose pliers. Check  
depth of sleeve. Insert  
sharp pointed tool between  
cap and thread sleeve and  
push or bend one side of thread  
sleeve to center of cap.  
Needle nose pliers can now  
be inserted between cap and  
sleeve. Grasp sleeve firmly  
and twist out.

#2 Check Clip Spring

#3 Remove Dents

-----  
-----  
Metal Cap Burnisher.  
With burnisher rub dent  
from inside.

**REASSEMBLE**

#1 Select Proper Thread Sleeve

#2 Cement Sleeve into Cap

-----  
-----  
EC847 Cement  
Alcohol Lamp  
Spread cement evenly over thread  
sleeve. Insert in cap to the  
proper depth. Wipe excess cement  
off cap with rag moistened with  
carbon tetrachloride. Hold open  
end of cap in flame of alcohol  
lamp and heat to approximately  
350°. Any more heat will cause  
the plastic clip sleeve to burn.

## SHEATH POINT CARTRIDGE PENS

### REPAIR INSTRUCTIONS

#### DISMANTLE:

1. Remove Point unit from barrel and pull off the plastic Skrip Cartridge.
2. Place entire Point and finger grip assembly in 120 degree water for 20 seconds. Shield the threads of thread bushing with a strip of rubber or flexible plastic inner cap (such as the one in the cap of this pen) and grip it in a Point Holder Pliers (Tool #32) and unscrew using a rubber pad to hold and turn gripping section.
3. Push feed back thru gripping section by pushing on feed finger. Be sure to watch for small compression gasket which is between feed and threaded bushing.
4. Unscrew point from finger grip.
5. Pull pierce tube from threaded bushing by gripping tube with a Filler tube alignment plier (Tool #23). Feed insert can be removed with the fingers.

#### ASSEMBLE:

1. Screw point on finger grip making sure it is tightly seated.
2. Push feed up through finger grip. The finger of the feed should be centered on the nib. This can be done by inserting the tip of a pencil in the hole on the bottom of the feed to hold the feed while assembling through the finger grip.
3. Place the compression gasket into the finger grip.
4. Make sure the friction ring is in place on the threaded bushing. Place a small amount of thread seal (#64 - 64A) on the small threads and assemble into gripping section.
5. If the pierce tube has been disassembled place it on the pierce tube assembly tool (#89). Place the correct spacer washer for the sheath type pens in place and push the pierce tube into the bushing until the spacer is against the bushing. The long side of the pierce tube should line up with the slit on the point.
6. Place the feed insert into the pierce tube with the flat side up (toward the point) and push through the assembled pierce tube. The insert must be pushed so that the end is shorter than the long edge of the angle on the pierce tube, but longer than the short edge.
7. Always test the writing and feeding by assembling a Skrip Cartridge on the completed assembly.

Any part or parts of the writing assembly can be cleaned or replaced by using the above sequence either in it's entirety or as required.

TO TIGHTEN CLIPS OR REMOVE DENTS ON CARTRIDGE PENS

1. Remove the plastic cap innerliner with a hooked inner cap puller (Tool #6) or a solid hook bar puller (Tool #1A).
2. Insert an Arbor for removing dents in Metal caps (Tool #26F) into the cap shell and position it under the ears of the clip or under the dent to be removed.
3. Tap gently on the clip over the clip ears with a plastic hammer (Tool #75) to reclinch the clip ears until the clip is tight. This same tool is used to remove dents by gently tapping about the dented area.
4. Re-push the plastic cap inner lever into the cap shell using a #2 size plastic pencil cap to force the innerliner to the end of the cap shell.

TO CLEAN CARTRIDGE PEN NIB UNITS

1. Remove the unit from the barrel and pull off the plastic Skrip Cartridge.
2. Insert the unit point first into a rubber bulb (Tool #59). The Sheath type will fit tightly in the mouth of the bulb but the Conventional type must be held with the head of the gripping section against the mouth of the bulb.
3. Insert the pierce tube into hot water and flex the bulb. This will force the water in and out of the unit and flush any sediment out of the feed and pierce tube insert.



## CONVENTIONAL POINT CARTRIDGE PEN

### REPAIR INSTRUCTIONS

#### DISMANTLE:

1. Remove point unit from barrel and pull off the plastic Skrip Cartridge.
2. Remove pierce tube with a Filling tube alignment pliers (Tool #23). Remove insert.
3. Remove point and feed from gripping section. This can generally be done with a Point pushing pliers and attachment (Tool #14). Be sure the jaw opposite the attachment is shielded with a rubber sac to prevent scarring the point. If the point and feed are too tight to be removed with pliers, position the unit point down in a Bench block for disassembling points and feeds (Tool #56) and insert a plunger rod through the hole in the gripping section and tap gently on the rod with a Bench hammer (Tool #58) until the feed and point are out of the gripping section.

#### ASSEMBLE:

1. Position the feed and point so the tip of the feed is approximately 1/8" from the tip of the point. Grip with a Point pushing pliers and attachment (Tool #14) (be sure the jaw away from the attachment is shielded with a rubber sac to keep from scarring the point) and push until the feed bottoms in the gripping section.
2. Place pierce tube on Pierce tube assembly tool (#89). Place the correct spacer washer for conventional point cartridge pens in place and push the pierce tube into the gripping section until the spacer is against the shoulder on the gripping section. The long side of the pierce tube should line up with the slit on the point.
3. Place the feed insert into the pierce tube with flat side up (toward the point) and push through the assembled pierce tube. The insert must be pushed so that the end is shorter than the long edge of the angle on the pierce tube, but longer than the short edge.
4. Always test the writing and feeding by assembling a Skrip Cartridge on the completed assembly.

Any part or parts of the writing unit can be cleaned or replaced by using the above sequence either in its entirety or as required. Complete writing units are also available.

ALL METAL RETRACTABLE BALLPOINT PENS

REPAIR INSTRUCTIONS

The slide collar mechanism in the all metal retractable ballpoint pens can be changed using the method described on page D8 of the repair manual except the reseating of the mechanism should always be done by hand as described in paragraph three of that page. The top of the cap is too "soft" to use the block.

Also the pushing tools sold prior to July 1957 must be slightly modified to be used with the all metal model. The outer diameter of the tool at the mouth is too large for the inner liner of the cap so that it cannot be inserted far enough to seat the mechanisms completely. The diameter of .262 must be reduced to approximately .250 at the edge of the mouth and tapered back gently.

This can be done by inserting the tool in a lathe and cutting it down with a file and smoothing the surface with sandpaper. Trying the size with a cap several times during the process will prevent removing too much material and ruining the tool.

The Service Department at the factory will turn down the tools for any repair station that does not have the proper facilities to do the job. This service will be provided at no charge. Simply return the tool in your next parts shipment and it will be modified and returned to you.

Tools sold after July 1957 can be used on all retractable models.

## LADY SHEAFFER SKRIPSERT PENS

### REPAIR INSTRUCTIONS

Point replacements on Lady Sheaffer Pens are made by using the same methods described on Page C11 for the Sheath Point Skripsert Pens. In both Lady Sheaffer and Sheath Point Skripsert Pens, applying a small amount of Arabol (#68 - 68A) on the threads under the point will help seal the point. Also, if the point appears to be spread after assembling, the feed should be heated so it will relax allowing the point to seek it's natural set.

The Point units can be cleaned without disassembling as described on Page C12.

### TO REMOVE DENTS FROM CAPS OR BARRELS

1. Remove the plastic or barrel innerliner using a Threaded Puller for Inner Liners. (Tool #91)
  - (a) Thread the Puller into the plastic liner until it has a firm grip.
  - (b) Apply a small amount of heat to the outside of the barrel or cap.
  - (c) Grip the cap or barrel in a rubber pad and pull out the liner.
  - (d) The cap shell or barrel shell can be cleaned with mineral spirits or gasoline if the rubber or heat marks it.
2. Insert an arbor for removing dents in metal caps (Tool #2 6F) into the cap or an arbor for removing dents in metal barrels (Tool #92) into the barrel.
3. Position the arbor under the dent to be removed and tap about the dented area with a plastic hammer (Tool #75).
4. Apply a bead of EC524 Name Plate cement (#93) three fourths of the way around the cap innersleeve and push it into the cap shell with a #2 size plastic pencil cap until the liner is 53/64" away from the mouth of the cap. Clean excess cement with cigarette lighter fluid.

Apply arabol cement (#68 - 68A) to the barrel liner and insert it into the barrel shell. Clean excess cement with water.

## AC18I SKRIPSERT PENS

### REPAIR INSTRUCTIONS

#### DISMANTLE:

1. Remove Point unit from barrel and pull off the Skrip Cartridge.
2. Place Point unit in 120 degree water for approximately 20 seconds. Shield the threads of the threaded bushing with a Plastic Thread Shield (#98). Grip the shielded threaded bushing with a Point Holder Pliers (tool #32) and unscrew the bushing from the gripping section using a rubber pad to hold and turn the gripping section. (This same Thread Shield (#98) can be used for dismantling the Lady Sheaffer and 500 and 875 Skripsert Pens.)
3. Push the point and feed back through the gripping section. Be sure to watch for the small compression gasket between feed and threaded bushing.
4. Strip the point from the feed with thumbnail or knifeblade.
5. Feed insert can be removed with the fingers. The pierce tube is removed from the threaded bushing with a Filler Tube Alignment Pliers (tool #23).

#### ASSEMBLE:

1. Push point on to feed until the side of the nib rests on the shoulder of the feed.
2. Insert feed and point into gripping section. The top of the point should be visible in the notched portion of the gripping section.
3. Wet the compression gasket with water or glycerine and place it into the gripping section. This will serve to lubricate the gasket and keep the feed from twisting when the threaded bushing is assembled. (Particularly helpful on Lady Sheaffer and other triumph point Skripsert Pens).
4. Make sure the friction ring is in place on the threaded bushing. (This ring will not interchange with Lady Sheaffer and other Skripsert Pens). Place a small amount of Thread Seal (#64-64A) on the small diameter threads and assemble into the gripping section using the pliers and thread shield to screw it in tightly. (The threaded bushing will not interchange with Lady Sheaffer or other Skripsert Pens. Can be identified with the small circle scribed around the pierce tube hole).
5. The Pierce tube and insert are assembled as described on page C11 or D8D using the brass spacer marked "sheath" for correct push length.
6. Test the writing by assembling a Skrip Cartridge on the completed assembly.

PFM PENS

REPAIR INSTRUCTIONS

DISMANTLE:

1. Remove the barrel by unscrewing it from the point unit threaded bushing.
2. Remove the sac protector assembly by pulling it out of the threaded bushing.
3. Insert threaded bushing tool-PFM (Tool #99) into the threaded bushing and unscrew the bushing from the gripping section using a rubber strip to hold the gripping section. Soaking in warm water for a few minutes will help loosen the thread seal in case normal pressure fails to loosen the joint.
4. Remove the metal seal gasket washer and the rubber point holder gasket. Remove the feed by pushing on the end of the feed finger.
5. Unscrew the plunger tube screw with a long shank screwdriver. After removing the plunger knob, push the plunger tube through the mouth of the barrel and remove the compression gasket.
6. To replace the plastic portion of the cap, disassemble the band and inner-cap by applying heat from a soldering iron to the inside of the inner cap. The cap plastic will warp from the heat, however, it will be exchanged for a new plastic shell at a nominal exchange fee. The clip spring is removed with a clip disassembling & assembly tool (Tool #16).

ASSEMBLE:

REPAIR INSTRUCTIONS

1. Replace the compression gasket in the barrel shell with a compression gasket positioning tool-PFM (Tool #100) in accordance with instructions for the use of the tool on page D3.
2. Replace the plunger tube into the barrel shell through the mouth end and push it through the compression gasket with a long shank screwdriver. Position the screw on the blade of the screwdriver and insert into and through the plunger tube. NOTE: Models AK14, AK14W, and AK15 use a 121SK screw. Models AK15WN and AK15G use a different screw to engage in the plunger knob ornament.
3. Place a plunger knob gasket on the screw and tighten the screw into the correct plunger knob. Lubricate the plunger tube with petrolatum (#95). Place the propelling spring around the plunger tube in the barrel.
4. Insert the tip of a pencil into the hole on the bottom of the feed to hold the feed in position and, with the pencil, push the feed up into the gripping section and point assembly. Be sure the feed finger is centered on the point.
5. Wet the point holder gasket and seal gasket washer with water or glycerine (#94) and place the gasket into the gripping section followed by the seal washer. Wetting will keep the feed from turning when the threaded bushing is tightened.
6. Position the friction ring into the three grooves in the gripping section with the open side of the friction ring away from the point.
7. Lubricate the end of the threaded bushing with water or glycerine (#94) and start into the gripping section. Place a small quantity of shellac (#71) on the threads and screw the threaded bushing tightly into the gripping section using a threaded bushing tool-PFM (#99). Make sure the feed finger is still centered on the point. If the point is distorted, use procedures on Pages C5, C6, and C8 to correct.
8. Place the end of the sac protector assembly containing the rubber bushing into water at least 180° F so that the water completely covers the four splines. Hold the assembly in this position for approximately two minutes to allow the rubber bushing to be heated, then remove and insert the filler tube into the sac protector assembly bushing. Dry the assembly with a cloth. Lubricate the filler tube with glycerine (#94) and insert through the hole in the point holder gasket and push out through the feed, lining up the four splines on the sac protector with the four grooves in the threaded bushing and keeping the slope on the filler tube as close in alignment with the slope on the feed as possible.
9. Assemble the barrel to the point unit applying shellac (#71) to the threads to help make the seal.
10. Retract the filler tube and, by using a filler tube alignment pliers (#23), turn, push or pull the tube so the slope is in alignment with the slope of the feed and is flush with the contour of the feed.
11. To assemble a new cap blank, position a clip spring into the clip spring assembly tool (Tool #16). Position the clip into the new blank and insert the spring through mouth of the cap into the box on the clip. Apply a small quantity of arabol cement (#58) to the inner cap and force it into the cap blank until the band seats against the plastic.

## SKRIPRITER BALLPOINT PENS

### REPAIR INSTRUCTIONS

This repair instruction covers the repair of the \$1.49, \$1.95 and \$2.49 Skripriter Ballpoint Pens introduced in 1959.

#### DISMANTLE:

1. To remove the mechanism sliding spring, make a tool by bending a small hook in a piece of wire (a paper clip will do). Place the mechanism in the depressed position. Insert the hooked tool into the mouth of the cap and, with the tool, push the mechanism shell away from the mouth. This will slide the spring out of the shell so it can be easily removed with the hooked tool. Mechanism failures can generally be corrected by replacing the sliding springs.
2. To remove the retracting mechanism, stand the cap mouth down on a smooth surface. Place the punch tool, (modified, see below\*), Tool Set #25, Tool for Removing and Assembling Ballpoint Mechanisms, Page D8, against the push rod and drive the mechanism out of the cap by tapping lightly on the punch.

\* The tool should be ground flat on two sides so it will fit into the oblong hole on top of the \$1.49 and \$1.95 models. The Service Department at the factory will grind these punches for any repair station not having the facilities to grind the flats. This service will be provided at no charge. Simply return the punch in your next parts shipment and it will be modified and returned to you.

#### ASSEMBLE:

1. The "U" shaped sliding mechanism spring should be "square". The sides of the "U" should be at right angles to the bottom and the bottom straight and not slanted or the mechanism will fail. Towards the top of the "U" the sides should slope out slightly.
2. To assemble a sliding spring into the mechanism inside the cap, insert the bottom of the spring into the mouth of a pushing tool, Tool Set #25, Tool for Assembling Ballpoint Mechanisms, Page D8, until the mouth of the tool rests on the bend in the short side of the spring. The slope on the sides of the spring should be enough so the spring holds in the mouth of the tool.
3. Hold the mechanism in the depressed position and insert the spring into the mechanism shell through the mouth of the cap. The long side will enter the shell first. A slight pressure toward the long side of the spring with the tool will compress the spring so the short side will enter the shell. Make sure the two sides of the spring are in the shell and push the spring forward into the shell. IMPORTANT: The sides of the spring must be seated in the grooves in the mechanism shell or the retracting action may fail.
4. To assemble a retracting mechanism with sliding spring, position the knurled collar down over both sides of the spring. On the \$1.49 and \$1.95 models line up the slope on the push button with the slope on the top of the cap (NOTE: The \$2.49 model takes a mechanism without slope) and drop the mechanism into the cap. Push the mechanism into place using the pushing tool from Tool Set #25.

## TARGET OR IMPERIAL III PENS

### REPAIR INSTRUCTIONS

#### DISMANTLE

1. Remove the barrel by unscrewing it from the point unit threaded bushing.
2. Remove the sac protector tube by pulling it off of the threaded bushing. The sac can then be removed from the sac trunion.
3. Grip the threaded bushing with a point holder pliers (Tool #32) and unscrew the threaded bushing from the gripping section.
4. Remove the feed insert. The feed and compression gasket can then be removed by pressing down on the end of the feed finger.
5. Unscrew the nib from the gripping section.
6. With a long shank screwdriver, unscrew the plunger tube screw and remove the plunger knob. The plunger tube can now be removed from the barrel. The barrel compression gasket can be removed with a pin or paper clip.

#### ASSEMBLE:

1. Using an "O" ring positioning tool - TM (Tool #15A) position the barrel compression gasket into the barrel. Insert the plunger tube down through the mouth of the barrel and reassemble the plunger knob with the long shank screwdriver.
2. Apply a small quantity of arabol cement (#68) to the point threads of the gripping section, screw the nib into place and wipe off the excess arabol.
3. Insert the tip of a pencil into the hole on the bottom of the feed to hold the feed in position and push the feed up into the gripping section and point assembly. Be sure the feed finger is centered on the point.
4. Wet the point holder gasket with water or glycerine (#94) and place the gasket into the gripping section. Wetting will keep the feed from turning when the threaded bushing is tightened into position.
5. Position the friction ring into the three grooves in the gripping section with the open side of the friction ring away from the point. Place a small quantity of arabol cement (#68) on the threads of the threaded bushing and screw it into place using the point holder pliers (Tool #32).
6. Assemble the feed insert through the threaded bushing with the fissure on the insert lined up with the slit of the nib. The flat side of the insert must be towards the top of the nib.
7. Apply a small quantity of shellac to the sac trunion on the threaded bushing and using a sac spreader (Tool #31) assemble the sac assembly. Put the sac protector tube on to the threaded bushing. Place a small quantity of DPR solution (#97) on the threaded bushing and screw the barrel into place.



## IMPERIAL TOUCHDOWN AND COMPACT PENS

### REPAIR INSTRUCTIONS

#### DISMANTLE

1. Remove the barrel by unscrewing it from the point unit threaded bushing.
2. **IMPERIAL ONLY** - Remove the sac protector tube by pulling it off the threaded bushing. Remove the sac from the sac trunion.
3. Grip the threaded bushing with a Point Holder Pliers (Tool #32) and unscrew the threaded bushing from the gripping section. Protect the threads on the Compact pen with a Thread Shield for Compact Pens (Tool #101).
4. Remove the feed insert. Remove the feed and compression gasket by pressing down on the end of the feed finger. On the Compact pen the pierce tube is removed from the threaded bushing with Filler Tube Alignment Pliers (Tool #23).
5. **IMPERIAL ONLY** - With a long shank screwdriver, unscrew the plunger tube screw and remove the plunger knob. Remove the plunger tube through the mouth of the barrel. Remove the barrel compression gasket with a pin or paper clip.

#### ASSEMBLE

1. **IMPERIAL ONLY** - Using an "O" Ring Positioning Tool - TM (Tool #15A) position the barrel compression gasket into the barrel. Insert the plunger tube through the mouth of the barrel. Reassemble the plunger knob with the long shank screwdriver.
2. Insert the tip of a pencil into the hole on the bottom of the feed to hold the feed in position and push the feed up into the point and gripping section. Be sure the feed is centered on the point.
3. Position the compression gasket in the gripping section tamping it down against the feed.
4. Position the friction ring into the three grooves in the gripping section with the open side of the friction ring away from the point. Place a small quantity of Arabol Cement (#68) (Imperial) or Thread Seal (#64) (Compact) on the forward threads of the threaded bushing and screw it into place using a Point Holder Pliers (Tool #32). Again, protect the threads on the Compact pen with a Thread Shield for Compact Pens (Tool #101).
5. **COMPACT ONLY** - Pierce tube is assembled as described on Page D8D using the brass spacer marked Sheath for correct push length.
6. Assemble the feed insert through the threaded bushing (through the pierce=~~tube~~ on the Compact) with the fissure on the insert lined up with the slit on the point. The flat side of the insert must be towards the top of the point. On the Imperial the insert should extend at least 1/64" from the face of the threaded bushing. On the Compact the insert must be pushed so that the end is shorter than the long side of the pierce tube but longer than the short side of the pierce tube. Make sure the long end of the pierce tube is sharp. If necessary sharpen it with a fine tooth file.
7. **IMPERIAL ONLY** - Apply a small quantity of Shellac (#71) to the sac trunion on the threaded bushing and using a Sac Spreader (Tool #31) assemble the sac. Push the sac protector tube over the sac on to the threaded bushing. Place a small quantity of DPR solution (#97) on the threads of the threaded bushing and screw the barrel into place.

## REMINDER CLIP BALLPOINT

### REPAIR INSTRUCTIONS

#### DISMANTLE

1. PLASTIC CAP - Insert the threaded end of a Retainer Sleeve Disassembling Tool (Tool #102) into the cap. Applying pressure, turn clockwise until the thread passes through the shoulder on the retainer sleeve with a definite snap. Pull the sleeve out with the tool. Remove the cam.

METAL CAP - Screw a barrel into the cap and remove the retainer sleeve by pulling while rocking the barrel thus "walking" the sleeve out. Remove the cam.

2. PLASTIC CAP - Through the cap mouth, with the hook of a Clip Spring Disassembling Tool (Tool #103) turned away from the clip, insert between the clip and spring until the hook slips behind the raised portion of the spring. Pull the spring out freeing the clip.

METAL CAP - Through the cap mouth, with the hook turned towards the clip, insert under the spring and engage the raised portion of the spring. Pull the spring out freeing the clip.

#### ASSEMBLE

1. PLASTIC CAP - The plastic cap spring is turned back over on top forming a raised portion. With this raised portion up, place the spring into the groove on a Clip Spring Assembling Tool (Tool #103). The movable band is not used and should be positioned at the handle. Hold the spring in position and slide into the cap off to one side of the clip holes. When the spring is beyond the first hole, rotate the tool until the spring is in line with the holes. Place the clip in position. Push the tool forward until the spring clicks into place.

LARGE METAL CAP - The sides of the metal cap spring are turned under forming a raised portion. Place the spring in the groove with the raised portion down. Hold in place with the movable band placed over the rolled under portion. Slide into the cap off to one side of the clip holes. When the spring is beyond the first hole, rotate the tool until the spring is in line with the holes. Place the clip in position. Bear down on the handle so the spring is rocked up towards the clip. Push forward until the spring clicks into place.

SMALL METAL CAP - Use same procedure as for plastic caps except spring for metal cap is used and the movable band positioned at the handle.

2. Hold the cap mouth up. Select the proper diameter cam, line up the sloped groove with the clip and drop the cam into place.
3. PLASTIC CAP - Place the retainer sleeve on the arbor end of the Retainer Sleeve Assembling Tool (Tool #102) and push into the cap until the mouth rests on the tool.

METAL CAP - Screw the retainer sleeve on a barrel and push into the cap until the end of the sleeve is flush with the cap mouth.

## DIAMOND SHAPED POINTS - (ENCLOSED FEED)

### Repair Instructions

#### CARTRIDGE TYPE

General dismantling and reassembling instructions for cartridge type pens are to be followed as in C11, C12, and C13. However, enclosed feed, diamond shaped points require additional attention in servicing.

Proceed with normal dismantling, removing threaded bushing, insert, gripping section, compression gasket, and friction ring. The gripping section with point and feed remain for further dismantling. The trick now is to get the feed out of the gripping section.

1. Obtain a 2-56-NC tap. A large hardware store or automotive supply shop would have one in stock. In a pinch you might use Servisette Tool #28. The tap will work better because the threads are finer. Turn the tap or puller (#28) into the center hole of the feed about two or two and one-half turns then pull straight out. Don't twist or turn, just pull straight out. The feed is like a square peg going into a square hole and there is purposely some tension or snugness built into the fit so the point will be held securely. (See special note #1)
2. Wiggle the point a little and tilt it up and down. It will come out of the gripping section easily. This completes dismantling. The parts can now be cleaned or replaced as required. (See special note #2)

#### Assemble

1. Note the small lug or key on the top side of the point near the heel. This key must fit into and behind a mating keyway formed on the inside wall of the gripping section. Insert the shank of the point into the gripping section on the diamond inlay end and maneuver it with slight upward pressure until the point shoulders rest against the gripping section and the lug has come into contact with the keyway.
2. Hold the point in this position for feed assembly. Note the feed finger is rectangular in shape, having a pronounced sharp shoulder at the junction of the finger and comb cut area. This shoulder must touch and rest upon a mating shoulder formed on the inside wall of the gripping section. Push the feed straight into the gripping section. Some slight resistance will be noted so it will be necessary to use a small rod or tool or the shank end of the tap to push the feed into final position against the shoulder stop. The feed finger will now hold the point in its correct location and position.
3. Re-assemble gripping section gasket, friction ring, and threaded bushing in the normal manner. (Manual page C11)
4. Replace insert and adjust pierce tube properly. (Manual page C11)
5. Always test for writing and feeding by assembling a Sheaffer cartridge on the completed assembly.

DIAMOND SHAPED POINTS - ENCLOSED FEED)

TOUCHDOWN

The above instructions relate also to the Touchdown filling models having the enclosed feed, diamond shaped inlay writing units after the writing units have been removed from the barrel assembly and the sac removed from the gripping section.

Special notes

- \* 1. Either the Eraser Puller Tool #28 or the 2-56-NC Tap will cut into the hole of the feed creating some hard rubber shavings. Do not thread either tool into the feed hole any farther than is necessary to pull feed out. Be sure to remove any burrs or shavings from the feed hole by an air blast or several sharp taps on a hard surface.
- \* 2 While point writing units are completely dismantled it is essential to thoroughly and completely clean the feed, inside of gripping section, insert and point of all writing fluid sediment and accumulation prior to re-assembly.

**SECTION**  
**D**

PENCIL PARTS AND PRICES

<u>NAME</u>	<u>FACTORY SYMBOL</u>	<u>LIST PRICE</u>	<u>ASSEMBLED CAP</u>	<u>BARREL</u>	<u>MECHANISM</u>	<u>TIP</u>
Handyman Pencil	WE	1.95	1.00	.60	.40	.50
Chrome Cap-pencil	H195	1.95	1.00	.60	.40	.50
Brass Cap-pencil	H196	1.95	1.00	.60	.40	.50
Cadet (T.P.)	T20-X	3.00	1.50	1.00	1.25	.50
Craftsman (TP)	T2-X	4.00	1.75	1.00	1.25	.50
"500" Pencil	C11T8W	3.75	1.50	2.00	1.25	.50
"875" Pencil	C11TLOW	5.00	2.00	2.00	1.25	.75
Admiral and Saratoga (TP)	T7	6.00	2.25	2.00	1.25	.50
Sovereign (TP) (Sheaffer clip)	T61-X	5.25	2.00	2.00	1.25	.75
Sovereign (TP) (Plain clip)	T60-X	5.25	2.00	2.00	1.25	.75
Statesman and Valiant (TP)	T4	7.25	3.25	2.00	1.25	.75
Clipper and Sentinel (TP)	<del>T6-X</del>	7.50	4.50	2.00	1.25	.75
Signature (TP)	T4-6	10.00	7.50	2.00	1.25	.75
Autograph (TP)	T4-auto	17.50	12.50	2.00	1.25	2.50
Autograph (TP) (New)	C11T4A	12.50	8.50	2.00	1.25	.75
Triumph (TP) (Band on Barrel)	TY9B	15.00	6.00	6.00	1.25	.75
Triumph (TP) (Band on Cap)	TY9	15.00	6.00	6.00	1.25	.75
Crest (TP)	T6	9.00	6.00	2.00	1.25	.75
Masterpiece (TP)	TZ	65.00	30.00	28.00	1.25	2.50
Sheaffer Utility Pencil	TE-X	1.95	1.00	1.00	1.25	.50
Lady Sheaffer	I-VI	4.95	2.00	2.00	1.25	.75
Lady Sheaffer	X-XIV	5.00	2.00	2.00	1.25	.75
Lady Sheaffer	XV-XXI	7.50	4.00	2.50	1.25	.75
Lady Sheaffer	XXXV	10.00	5.00	3.50	1.25	.75
"PEP" Pencil	CF10&CF12F	2.00	1.00	.50	.40	.50
Desk Pencil (TP)	D4	5.00	3.25	1.00	1.25	.75
			(quill & barrel)	(Gripping Section)		
<u>OLDER LINES</u>						
Craftsman	H3	3.00	1.50	1.00	1.00	.50
Admiral	H5	3.75	1.75	1.00	1.00	.50
Statesman	H7	4.00	1.85	1.00	1.00	.75
Tuckaway	M7	4.00	1.85	1.00	1.00	.75
Statesman and Valiant TM	H40	5.00	2.75	1.00	1.00	.75
Sentinel Deluxe	H6XC	5.00	2.85	1.00	1.25	.75
Sentinel Deluxe Tuckaway	M6XC	5.00	2.85	1.00	1.25	.75
Crest Deluxe	H6	7.50	4.85	1.00	1.25	.75
Crest Deluxe Tuckaway	M6	6.00	3.85	1.00	1.25	.75
Signature	H40-6	10.00	7.00	1.00	1.25	.75
Autograph	H4-auto	15.00	10.50	1.00	1.25	2.50
Autograph Tuckaway	M4-auto	15.00	10.50	1.00	1.25	2.50
Triumph (Metal)	Y9B	12.50	6.00	6.00	1.25	.75
Desk Pencil	LD6	6.50	3.90	1.00	1.25	.75
			(quill & barrel)	(Gripping Section)		

NOTE: FOR PENCIL PARTS EXCHANGE PRICES PLEASE SEE PAGE D13

8/1/62

D1

PENCIL PARTS AND PRICES

<u>NAME</u>	<u>FACTORY SYMBOL</u>	<u>LIST PRICE</u>	<u>CAP</u>	<u>CAP SHELL</u>	<u>CLIP</u>	<u>CLIP SPRING</u>	<u>CAP LINER</u>	<u>BAND</u>	<u>WHITE DOT</u>	<u>ORNAMENT</u>	<u>BARREL</u>	<u>MECHANISM</u>	<u>TIP</u>
Gold Pep Pencil	CFY	\$2.95	\$1.50	None	--	None	--	None	None	None	\$ .50	\$1.00	\$ .50
White Dot Pencil III	CM9Y	7.50	3.25	1.80	1.25	.20	.50	None	.10	--	2.50	1.25	.75
Compact I Pencil	CC4-X	3.95	1.50	1.25	.75	.20	None	.30	None	None	1.00	1.25	.50
Compact II Pencil	CC4	4.95	2.20	1.25	1.00	.20	None	.35	.10	None	1.00	1.25	.75
IMPERIAL III or TARGET	CM3	4.00	2.00	None	--	None	None	--	None	None	1.00	1.25	.50
PFM I Pencil	CMX	4.95	2.75	1.25	1.00	.20	None	.30	None	None	1.00	1.25	.50
PFM II Pencil	CMW	5.00	2.75	--	1.25	.20	.50	None	.10	None	1.00	1.25	.50
PFM III or IMPERIAL IV Pencil	CM	5.00	2.75	1.25	1.25	.20	None	.35	.10	None	1.00	1.25	.75
PFM IV or IMPERIAL VI Pencil	CMWN	7.50	5.00	--	1.25	.20	.50	.50	.10	None	1.00	1.25	.75
PFM V Pencil	CMG	10.00	7.00	--	1.25	.20	.50	None	.10	None	1.00	1.25	.75
PFM Autograph	CMA	12.50	8.50	1.25	1.25	.20	None	5.80	.10	None	1.00	1.25	.75
500 Series Pencil	CM3W	3.95	1.75	--	.75	--	.25	--	--	--	1.00	1.00	.50
800 Series Pencil	CM3N	5.00	2.75	--	1.25	.20	None	.50	None	--	1.00	1.00	.50
1000 Series Pencil	CM6Y	6.00	3.75	--	1.25	.20	.25	--	--	--	2.00	1.00	.50

NOTE: FOR PENCIL PARTS EXCHANGE PRICES, PLEASE SEE PAGE DL3.

BALLPOINT PARTS AND PRICES

NAME	FACTORY SYMBOL	LIST PRICE	CAP	CLIP	CLIP SPRING	BAND & SLEEVE	BARREL	GRIPPING SECTION	FRICITION RING	UNIT	WHITE DOT	BARREL SPRING
<u>SLIP CAP MODELS</u>												
Smoothie	152-B	\$1.75	.50	None	None	None	\$ .50	\$ .50	\$ .10	\$	None	None
Admiral or Saratoga	R6T	5.00	2.75	1.00	.20	.75	1.00	.75	.10	.79	None	None
Sovereign	R3TX	5.00	2.75	1.50	.20	None	1.00	.75	.10	.79	None	None
	R3LTX											
Statesman or Valiant	R4T	6.00	3.75	1.50	.20	1.75	1.00	.75	.10	.79	.10	None
Clipper or Sentinel	R9T-X	7.50	4.50	1.50	.20	.75	1.00	.75	.10	.79	.10	None
Crest	R9T	9.00	6.00	1.50	.20	None	1.00	.75	.10	.79	.10	None
Signature	R4T-6	10.00	8.50	1.50	.20	7.00	1.00	.75	.10	.79	.10	None
Autograph	R4T Auto	17.50	13.00	6.00	.20	7.00	1.00	.75	.10	.79	.10	None

SLIDE CAP RETRACTABLE MODELS

White Dot Stainless	B15CY	10.00	5.00	--	None	None	4.25	None	None	.79	.10	.05
White Dot Gold Filled	B14CY	15.00	7.50	--	None	None	6.75	None	None	.79	.10	.05

8/1/62

NAME	FACTORY SYMBOL	LIST PRICE	CAP	SLIDE SPRING	PUSH ROD	MECHANISM SLIDING SPRING	SLIDE COLLAR MECH.	SLIDE COLLAR PUSH BUTTON	TIP AND BARREL ASSEMBLY	UNIT
Brass Cap Utility	SL96	\$ 1.95	\$1.00	None	None	None	\$ .50	\$ .05	\$ .50	\$ .79
Chrome Cap Utility	SL95	1.95	1.00	None	None	None	.50	.05	.50	.79
Plastic Cap Retractable	B	1.95	1.00	None	None	None	.50	.05	.50	.79
Valiant	SL4	2.95	1.75	None	None	None	.50	.05	.75	.79
Sentinel	SL6-X	3.95	2.75	None	None	None	.50	.05	.75	.79
Crest	SL6	7.50	6.00	None	None	None	.50	.05	.75	.79
Signature	SL4-6	10.00	8.50	None	None	None	.50	.05	.75	.79
All Metal Anodized	SBR	2.95	1.50	None	None	None	.50	.05	.75	.79
\$1.95 Skripwriter	BHI	1.95	1.00	.20	.20	.05	None	None	.50	.79
\$2.49 Skripwriter	BHW	2.49	1.25	.20	.20	.05	None	None	.50	.79
\$1.49 Ballpoint	BHX	1.49	.70	.20	.20	.05	None	None	.30	.79
Chrome Pep Ballpoint	HRFI	1.95	1.00	None	None	None	.50	.05	.50	.79
\$1.95 Ballpoint	HRI	1.95	1.00	None	None	None	.50	.05	.50	.79

PUSH BUTTON RETRACTABLE MODELS

Brass Cap Utility	SL96	\$ 1.95	\$1.00	None	None	None	\$ .50	\$ .05	\$ .50	\$ .79
Chrome Cap Utility	SL95	1.95	1.00	None	None	None	.50	.05	.50	.79
Plastic Cap Retractable	B	1.95	1.00	None	None	None	.50	.05	.50	.79
Valiant	SL4	2.95	1.75	None	None	None	.50	.05	.75	.79
Sentinel	SL6-X	3.95	2.75	None	None	None	.50	.05	.75	.79
Crest	SL6	7.50	6.00	None	None	None	.50	.05	.75	.79
Signature	SL4-6	10.00	8.50	None	None	None	.50	.05	.75	.79
All Metal Anodized	SBR	2.95	1.50	None	None	None	.50	.05	.75	.79
\$1.95 Skripwriter	BHI	1.95	1.00	.20	.20	.05	None	None	.50	.79
\$2.49 Skripwriter	BHW	2.49	1.25	.20	.20	.05	None	None	.50	.79
\$1.49 Ballpoint	BHX	1.49	.70	.20	.20	.05	None	None	.30	.79
Chrome Pep Ballpoint	HRFI	1.95	1.00	None	None	None	.50	.05	.50	.79
\$1.95 Ballpoint	HRI	1.95	1.00	None	None	None	.50	.05	.50	.79

PROCEDURES FOR REPAIR: Slide Collar Mechanism, Page D8; All Metal, Page C14; Slide Spring Mechanism, Page C19.  
 NOTE: FOR BALLPOINT EXCHANGE PRICES SEE PAGE D13.



BALLPOINT PARTS AND PRICES

<u>NAME</u>	<u>FACTORY SYMBOL</u>	<u>LIST PRICE</u>	<u>CAP</u>	<u>CAP SHELL</u>	<u>CLIP</u>	<u>CLIP SPRING</u>	<u>CAM</u>	<u>INNER SLEEVE</u>	<u>BAND</u>	<u>WHITE DOT</u>	<u>TIP AND</u>		<u>UNIT</u>
											<u>BARREL ASSEMBLY</u>	<u>BARREL SPRING</u>	
<u>REMINDER CLIP MODELS</u>													
\$1.95 Reminder Clip	BJ4I	1.95	1.00	.25	.10	.10	.10	.30	None	None	.40	.05	.79
Gold Pep Ballpoint	BJ4Y	3.95	2.55	.50	1.25	.10	.10	.30	None	None	.40	.05	.79
\$2.95 Reminder Clip	BJ3W	2.95	1.75	.50	.75	.10	.10	.30	None	None	.40	.05	.79
White Dot Reminder Clip	BJ3	3.95	2.50	.50	1.50	.10	.10	.05	.35	.10	.40	.05	.79
White Dot Ballpoint III	BJ7Y	7.50	4.50	2.75	1.50	.10	.10	.30	None	.10	2.50	.05	.79
\$1.95 Reminder, PEP II	BJ4I-2	1.95	1.00	.25	.10	.10	.10	.30	None	None	.40	.05	.79
<u>SPINNER-RATCHET MODELS</u>													
\$1.00 Spinner	BPO-X	1.00	.50	None	None	None	None	None	None	None	.25	.05	.79
\$1.00 Spinner	BPI	1.00	.50	None	None	None	None	None	None	None	.25	.05	.79

GRIPPING SECTION & THREAD RING

<u>NAME</u>	<u>FACTORY SYMBOL</u>	<u>LIST PRICE</u>	<u>GRIPPING SECTION</u>	<u>THREAD RING</u>	<u>THREAD RING</u>	<u>QUILL</u>	<u>BARREL &amp; QUILL</u>	<u>BAND</u>	<u>BARREL SPRING</u>	<u>WHITE DOT</u>	<u>UNIT</u>
Black		\$1.95	\$ .60	None	None	\$ .60	None	\$ .25	None	None	\$ .79
Colored		2.45	.85	None	None	.85	None	.25	None	None	.79
White Dot Desk Ballpoint	S4TD	5.00	1.25	.50	1.75	None	3.25	None	.05	.10	.79

DESK BALLPOINT MODELS

PROCEDURES FOR REPAIR: Reminder Clip Ballpoints, Page C23.

NOTE: FOR BALLPOINT EXCHANGE PRICES, SEE PAGE D13.

## POSITIONING TOOL FOR COMPRESSION GASKET

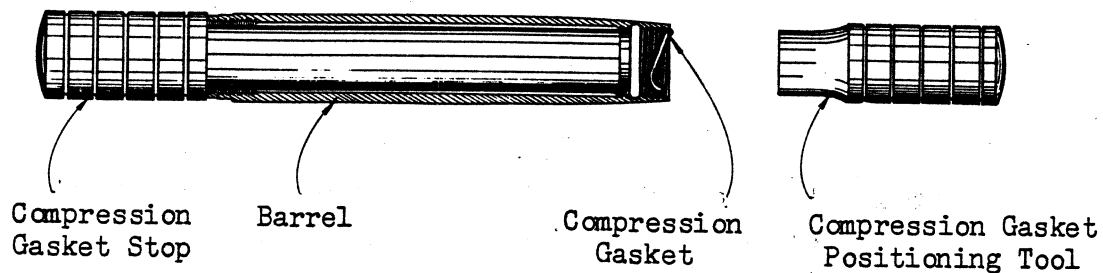

### INSTRUCTIONS FOR USING COMPRESSION GASKET POSITIONING TOOLS

Three sizes: Thin Model, Regular & Snorkel

1. Dismantle barrel. Refer to disassembly instructions. Section C
2. Insert compression gasket stop tool in trunnion end of barrel (the end that has the metal ferrule) as far as it will go.
3. Start compression gasket into opposite end of barrel.
4. Use compression gasket positioning tool, and push and rotate tool to position gasket in recess.
5. Check gasket after removing positioning tool to be sure it is in recess.

CONVENTIONAL POINT & FEED PUSHING TOOL  
PRICE \$ 2.25 EACH - NET  
(WITHOUT PLIERS)

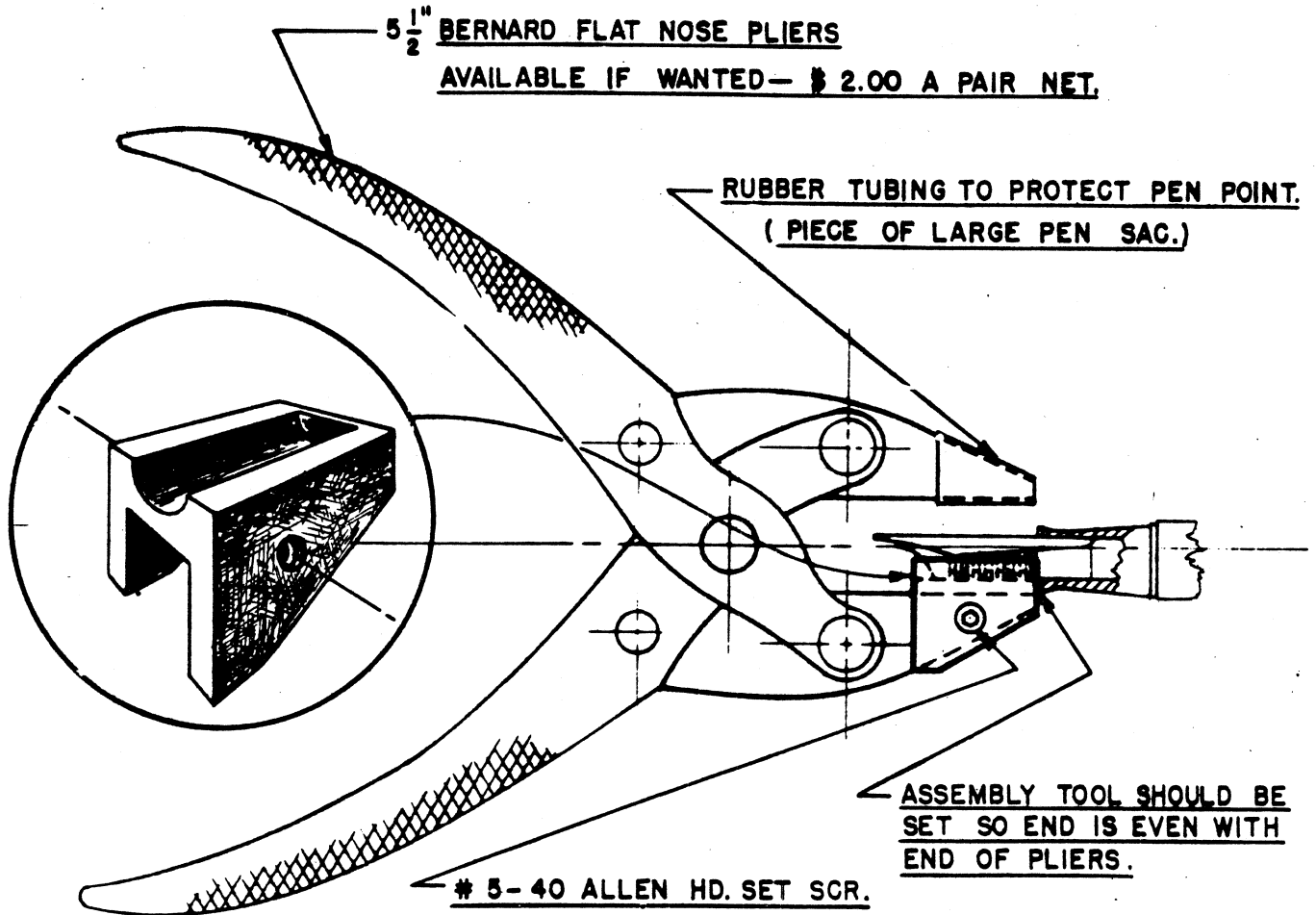

NOTE:

THE POINT & FEED ARE TO BE POSITIONED & STARTED INTO THE GRIPPING SECTION. THE FIN ON THE ASSEMBLY TOOL IS TO BE PLACED IN THE LAST COMB CUT IN FEED. THE POINT & FEED SHOULD THEN BE PUSHED INTO THE GRIPPING SECTION UNTIL NOSE OF PLIERS TOUCHES FACE OF SECTION.

SEEAFFER'S REPAIR SERVICE TOOLS AND SUPPLIES

<u>STOCK NO.</u>	<u>NOMENCLATURE</u>	<u>NET PRICE*</u>
1	Two Prong Bar Puller for 2T-2V-4T-8T	.50
1A	Solid Hook Bar Puller for 2-4-8 Two Piece Bar	.50
2	Bar Pusher for 8T	.80
3	Bar Pusher for 2T - 4T	.80
4	Bar Pusher for 2, 4, & 8 Two Piece Bars	.50
5	Lever Assembly Tool	1.00
6	Hooked Inner Cap Puller	1.00
7	Cap Thread Chaser .310-30	1.70
8	Barrel Thread Chaser .310-30	1.50
9	Vac Fill Plunger Removing Tool	.50
10	Vac Fill Plunger Lead	.40
11	Vac Fill Plunger Assembly Tool	.25
12	Vac Fill Lock Nut Wrench	.50
13	Tool for Removing Broken Point Holders	.75
14	Point Pushing Pliers & Attachment	4.25
14A	Point Pushing Attachment Only	2.25
15	"0" Ring Positioning Tool - Snorkel	.75
15A	"0" Ring Positioning Tool - TM	.75
15B	"0" Ring Positioning Tool - 920S	.75
16	Clip Spring Disassembling & Assembly Tool	1.25
17	Burnishing Tool	.75
18	V. Block for Sizing Pencil Mechanism	.25
19	Pin Vise	.75
20	Nib Pliers	1.75
21	Cutting Pliers	1.75
22	Needle Nose Pliers	2.25
23	Filler Tube Alignment Pliers	2.25
24	Gripping Section Tool - Snorkel	1.65
25	Tool for Removing and Assembling Ballpoint Mechanism & Assortment of Replacement Mechanisms	3.00
25A	Tool for Removing and Assembling Ballpoint Mechanisms (Tool Only)	2.00
26	Arbors for Removing Dents in Metal Caps - Snorkel - TM	2.50
26A	Arbors for Removing Dents in Metal Caps - #2 Size	2.50
26B	Arbors for Removing Dents in Metal Caps - #4 Size	2.50
26C	Arbors for Removing Dents in Metal Caps - #4.9 Size Pencils	2.50
26D	Arbor for Removing Dents in Metal Caps - #2 Size pencils	2.50
26E	Arbor for Removing Dents in Metal Caps - TP & Y9B Pencils	2.50
26F	Arbor for Removing Dents and tightening clips - Sheath type Cartridge pens	2.50
26G	Arbor for Removing Dents and Tightening Clips - Conventional Point Cartridge pens	2.50
27	Feed Broach - Snorkel Pens	.75
28	Eraser Pullers for Erasers Stuck in Caps	.35
29	Section Pliers	2.00
30	Feed Punches	.75
31	Sac Spreader	1.25
32	Point Holder Pliers Triumph	2.50
33	Drills for Fineline Pencil Tips .036	.35
34	Drill .050 for Large Pencil Tips	.35
35	Drills 5/16" for #2 Size Barrel Plugs	2.00
36	Drills 11/32" for #4 Size Barrel Plugs	2.00
37	Taps .311-36 for #79 & 92 Nib Units	5.50
38	Taps .311-40 for #93 Nib Units	5.50
40	Reamers .204 for #23-33 & 73 Sections	4.50
41	Reamers .234 for 5 & 74 Sections	4.50
42	Reamers .275 for #8 Sections	4.50
43	Point Push Gauge	2.25
44	Clip Spring Tool - Od Style	1.25

<u>STOCK NO.</u>	<u>NOMENCLATURE</u>	<u>NET PRICE *</u>
45	Clasp Spring Tool - Old Style	1.25
46	Inside Cutting Tool	1.00
51	Linen Tester (Point Magnifying Glass)	.50
52	Steel Rule 6 Inch	.25
53	Gold Wax for Filling Engravings	.10
54	Silver Wax for Filling Engravings	.10
55	Red Rouge for Polishing Sticks & Smoothing	.10
56	Bench Block for Disassembling Points & Feeds	.75
57	Burnishing Blocks for Ironing Bent Points	4.00
58	Bench Hammer - Steel Head	1.00
59	Rubber Bulbs	.15
60	Blank Files for Hand Turning Tools	.25
61	Alcohol Lamps	.50
62	Polishing Stick	.25
63	Finger Cot	.10
64	Thread Seal 5/8 Oz. (Rosin & Castor Oil)	.25
64A	Thread Seal, 1 Pint (Rosin & Castor Oil)	.75
65	Polishing Cloth	.75
66	Rosin, Lead Tube	.50
67	Cleaning Powder for Points & Feeds (Trisodium Phosphate)	.25
68	Arabol Cement, 5/8 Oz.	.25
68A	Arabol Cement, 1 Pint	1.25
69	EC 847 Cement 5/8 Oz.	.25
69A	EC 849 Cement, 1 Quart	2.00
70	MC Thinner 5/8 Oz.	.25
70A	MC Thinner, 1 Quart	1.25
71	Shellac, 5/8 Oz.	.25
71A	Shellac, 1 Pint	1.75
72	Rosin Flux, 5/8 Oz.	.25
74	Rubber Hose	.25
75	Plastic Hammer	1.25
82	Door Ease	.25
83	Burnisher for Ironing Bent Points	1.25
84	Polish, 1/4 Bar for Polishing Holders	.50
85	Smoothing Paper (3 x 4" per sheet)	.05
86	Spiral Brush	.25
87	Oakite Cleaning Powder for Caps & Barrels, 1 lb.	.50
88	Hand Turning Tool	.60
89	Pierce Tube Assembly Tool - Sheath Type and Conventional Cartridge Pens	1.50
90	Arbor for Tightening clips and sizing barrel mouths - All-Metal Ballpoints	1.60
91	Threaded Puller for Inner Liner	.45
92	Arbor for Removing Dents in Metal Barrels - Lady Sheaffer	2.50
93	EC 524, Nameplate cement, 5/8 oz.	.25
94	Glycerine, 5/8 oz.	.25
95	Petrolatum, 5/8 oz.	.25
96	Spermaceti and Castor Oil, 5/8 oz.	.25
97	DPR Solution, 5/8 oz.	.25
98	Plastic Thread Shield for Skripsert Pens	.15
99	Threaded Bushing Tool - PFM	1.65
100	Compression Gasket Positioning Tool - PFM	.75
101	Plastic Thread Shield for Compact Pens	.15
102	Retainer Inner Sleeve Assembling & Disassembling Tool - Reminder Clip Ballpoint	2.50
103	Clip Spring Assembling & Disassembling Tool - Reminder Clip Ballpoint	2.75

\* Prices are subject to change without notice.

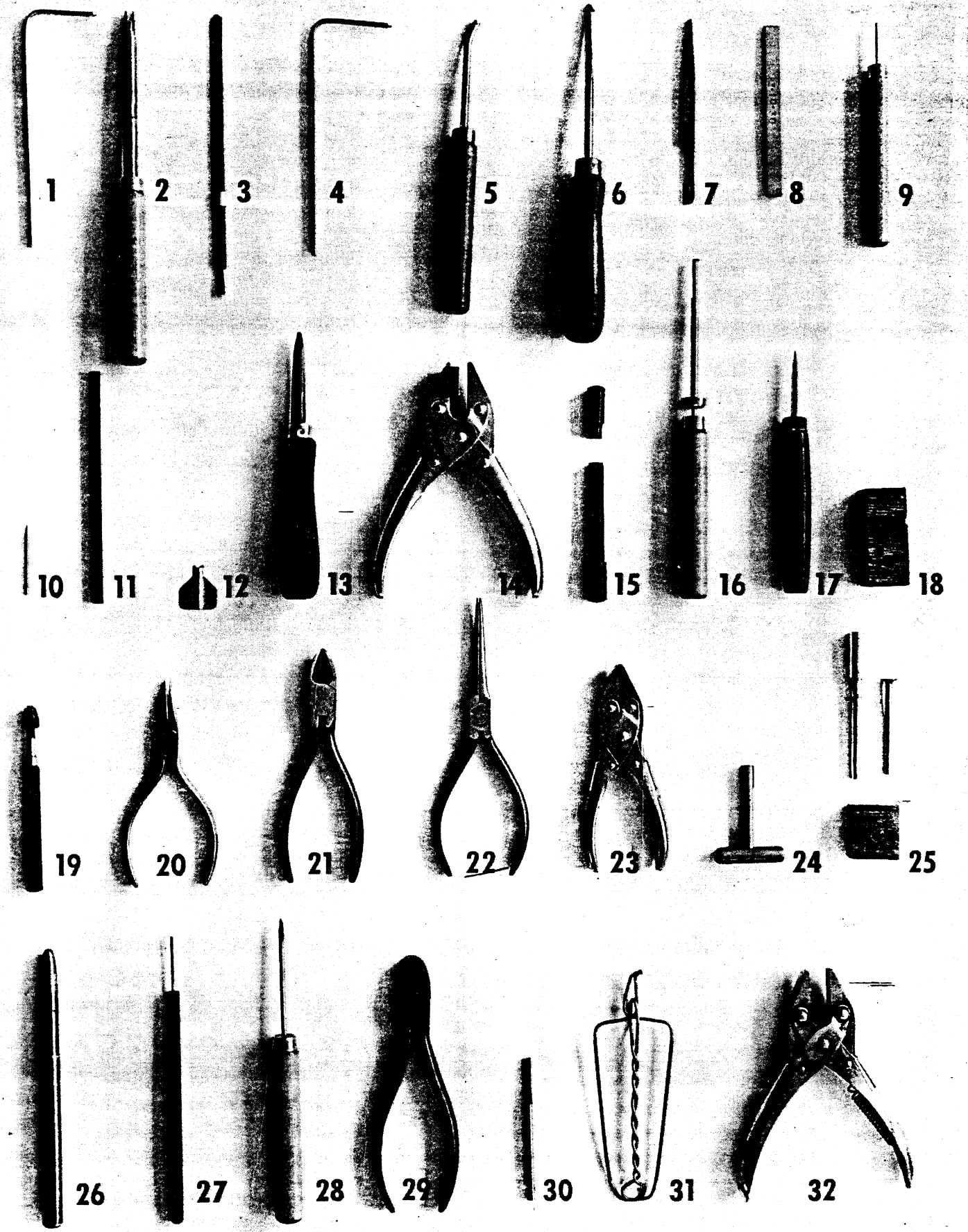

MECHANISM REPLACEMENT TOOL SET

CLICKER BALLPOINT PENS

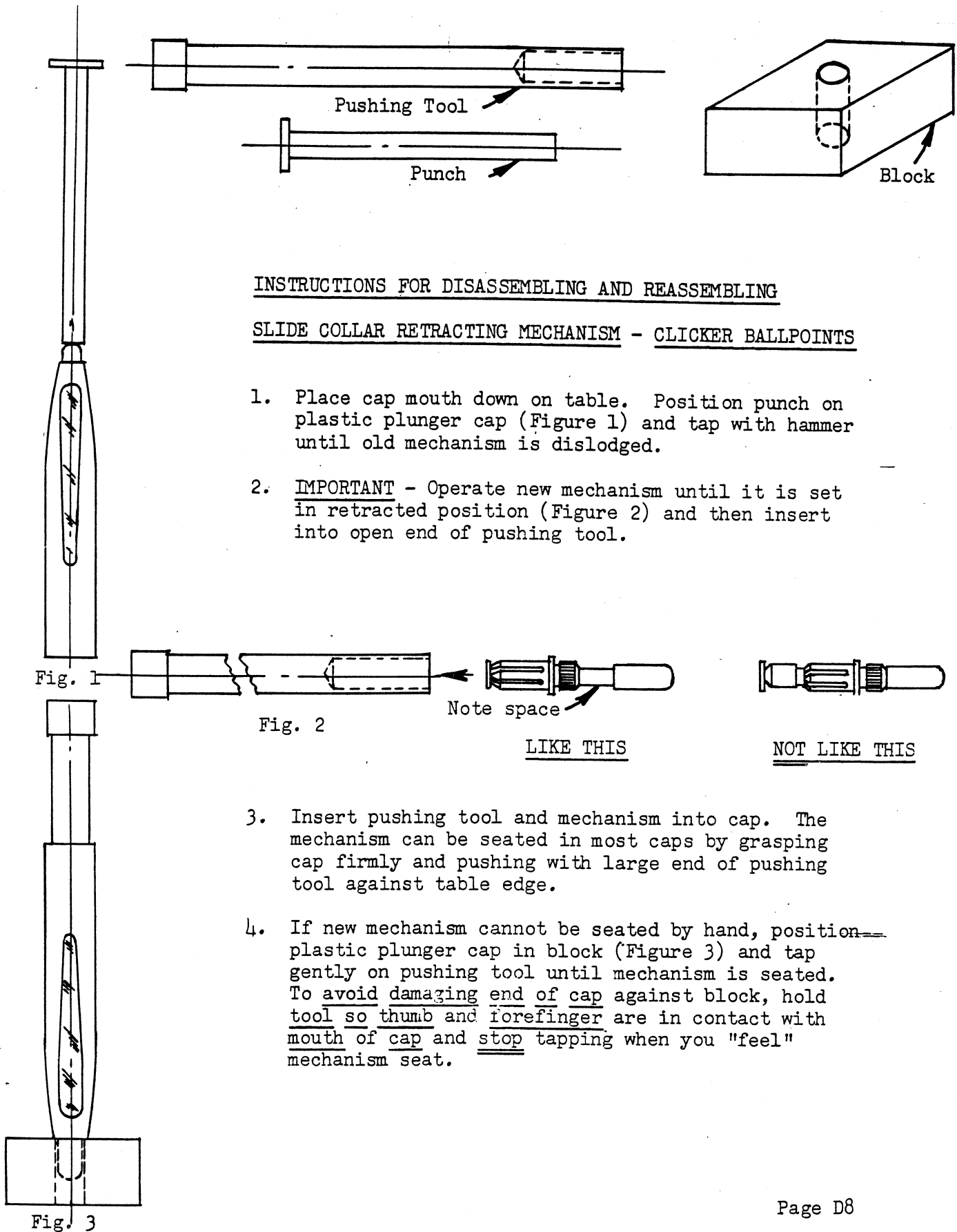

INSTRUCTIONS FOR DISASSEMBLING AND REASSEMBLING

SLIDE COLLAR RETRACTING MECHANISM - CLICKER BALLPOINTS

1. Place cap mouth down on table. Position punch on plastic plunger cap (Figure 1) and tap with hammer until old mechanism is dislodged.
2. IMPORTANT - Operate new mechanism until it is set in retracted position (Figure 2) and then insert into open end of pushing tool.

3. Insert pushing tool and mechanism into cap. The mechanism can be seated in most caps by grasping cap firmly and pushing with large end of pushing tool against table edge.
4. If new mechanism cannot be seated by hand, position plastic plunger cap in block (Figure 3) and tap gently on pushing tool until mechanism is seated. To avoid damaging end of cap against block, hold so thumb and forefinger are in contact with mouth of cap and stop tapping when you "feel" mechanism seat.

LIKE THIS

NOT LIKE THIS

## GRIPPING SECTION TOOL

### SNORKEL PEN

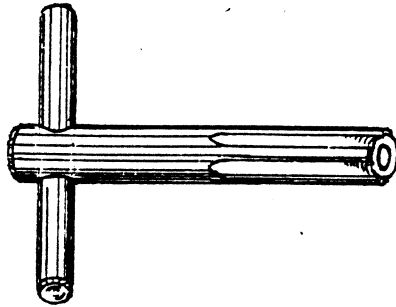

This tool is for removing the threaded portion of the gripping section that remains in the Snorkel Pen barrel in case a gripping section becomes broken.

### INSTRUCTIONS FOR USE

1. Leave the filler tube assembled in the sac bushing. The tool has a hole which will accommodate the tube.
2. Line splines in sac protector up with splines in threaded piece and retract filler tube by turning plunger knob to right in the regular manner. (Remember - some will have a large spline.) This will pull sac protector down through threaded piece so that tool can engage in threaded piece.

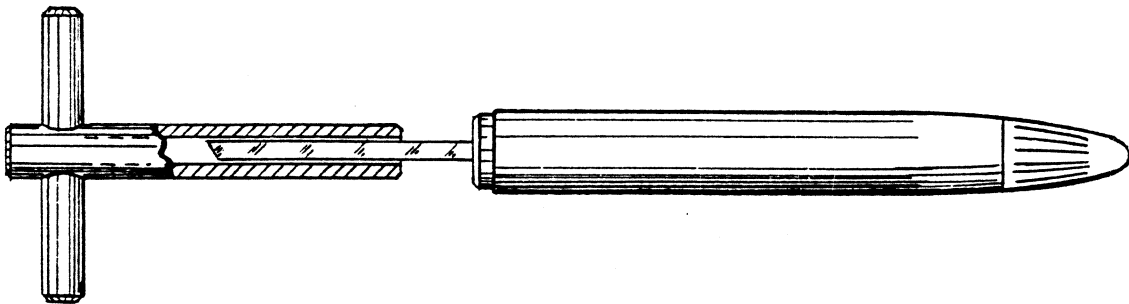

3. Position tool with filler tube in hole and engage splines on tool with splines on threaded piece.
4. Turn tool to left to unscrew threaded piece and allow the plunger knob to unscrew. As the threaded piece is unscrewed push in on tool to keep maximum engagement and not allow propelling spring to push sac protector out and disengage tool.



FEED BROACH

SNORKEL PEN

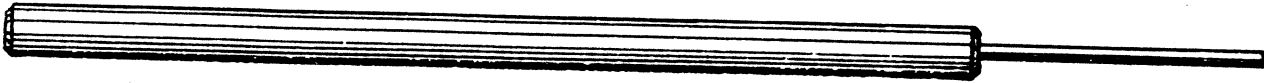

This tool is to be used for removing binds in Snorkel pen filling tube action.

INSTRUCTIONS FOR USE

This filler tube should extend from the pressure of the propelling spring. It should retract smoothly and easily. If there is a bind in the action and inspection reveals that the splines on the sac protector do not bind or are mismatched with the splines in the gripping section, the difficulty may be in the fit between the filler tube and the feed.

1. Remove point unit from gripping section.
2. Insert feed broach into hole in feed from the back of the unit.

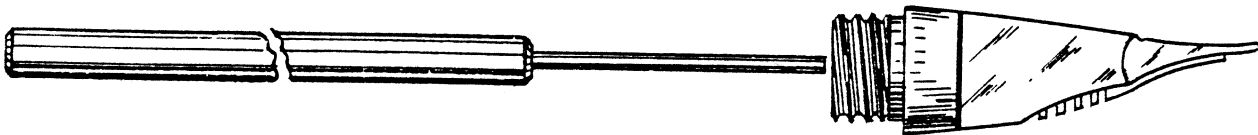

3. Press cutting edge of broach against side of hole on the long or finger side of the feed and push broach forward through feed. Be sure and blow all shavings out of feed.
4. Try fit and repeat above as necessary.
5. If broaching the hole in the feed does not correct the binding, check the fit of the point holder gasket on filler tube. If the gasket is tight, lubricate filler tube with petrolatum. C A U T I O N: Apply petrolatum on that part of filler tube that is on barrel side of gasket and never on portion that enters feed.

## ERASER PULLER

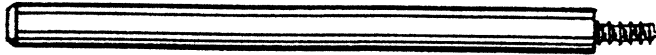

This tool is to be used for removing erasers that may become stuck in pencil caps.

### INSTRUCTIONS FOR USE

All Sheaffer pencil caps have ample clearance for the eraser however, sometimes the eraser comes out of the mechanism and becomes lodged in the cap, so that the mechanism with a new eraser will not fit. The old eraser can easily be removed with this tool:

1. Insert Threaded end into pencil cap.
2. Start thread in the small hole in the eraser cup and turn engaging the threads in the hole.

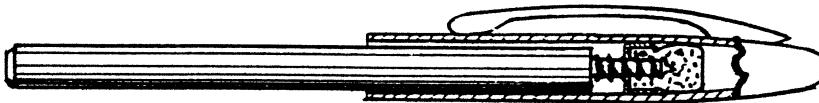

3. Pull out the old eraser after the threads engage in the hole.
4. If the eraser has no metal cup the threads will engage in the rubber like a cork screw so the tool may also be used on this type of eraser.

PIERCE TUBE ASSEMBLY TOOL #89

CARTRIDGE PENS

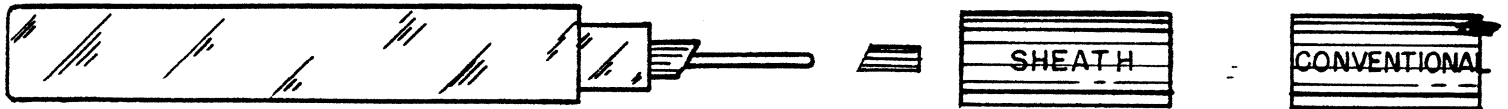

This tool is for assembling the pierce tube into the gripping section or threaded bushing. It is designed for use with either the conventional point cartridge pen or the sheath point cartridge pen.

INSTRUCTIONS FOR USE

1. Place pierce tube on pilot rod with angle against the angle on the tool. The longer edge of the pierce tube is sharp so it will pierce the plastic skrip cartridge. By properly placing the tube on the angle this sharp edge will be positioned over the secondary angle on the tool thus not dulling the edge.
2. Position the correct brass spacer (conventional or sheath) on the trunion of the tool.

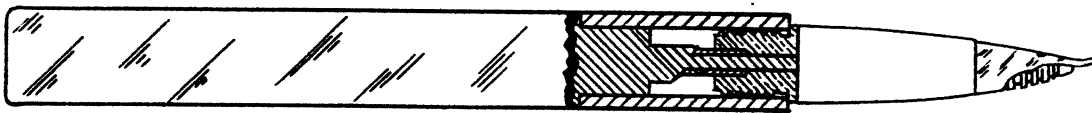

3. The longer portion of the pierce tube should be aligned with the point. This is done by lining the flat on the handle with the point (this flat is correctly aligned with the angle). Insert the pilot into the pierce tube hole in the gripping section (conventional point type) or the thread bushing (sheath point type) and push until the spacer rests against the shoulder on the gripping section. It may be necessary to place the gripping section point down in a Bench Block for Disassembling Points and Feeds (#56) and tap gently on the handle of the tool to drive the pierce tube into the hole.
4. Remove the tool and the spacer from the tool. Run the pilot back and forth through the pierce tube to loosen any burr that the pierce tube may have pushed up. Remove the tool and tap the assembly with pierce tube down several times to shake any burrs out.

Complete repair instructions for cartridge pens on pages C11, C12, and C13.

ARBOR FOR TIGHTENING CLIPS AND  
SIZING BARREL MOUTHS #90

ALL-METAL BALLPOINT PENS

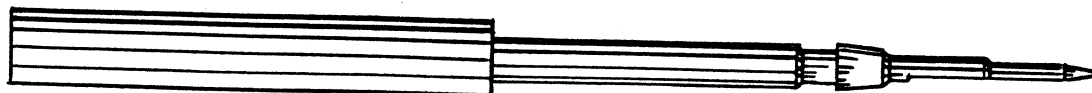

This is a combination tool that can be used for tightening the clips in all-metal retractable ballpoint pens or opening up the mouths of the barrels on the all-metal ballpoints that have been bent.

INSTRUCTIONS FOR USE

**TIGHTEN CLIPS:**

1. Remove the retracting mechanism as described on manual page D8.
2. Insert arbor into cap holding the arbor against one side of the cap. A definite "click" will be felt when the anvil area of the arbor clears the inner sleeve and is under the clip ears.
3. Place the end of the arbor on a table, flattened area directly under the clip ears. Hold the cap forward slightly so the end of the inner sleeve will be against the edge of the anvil area.

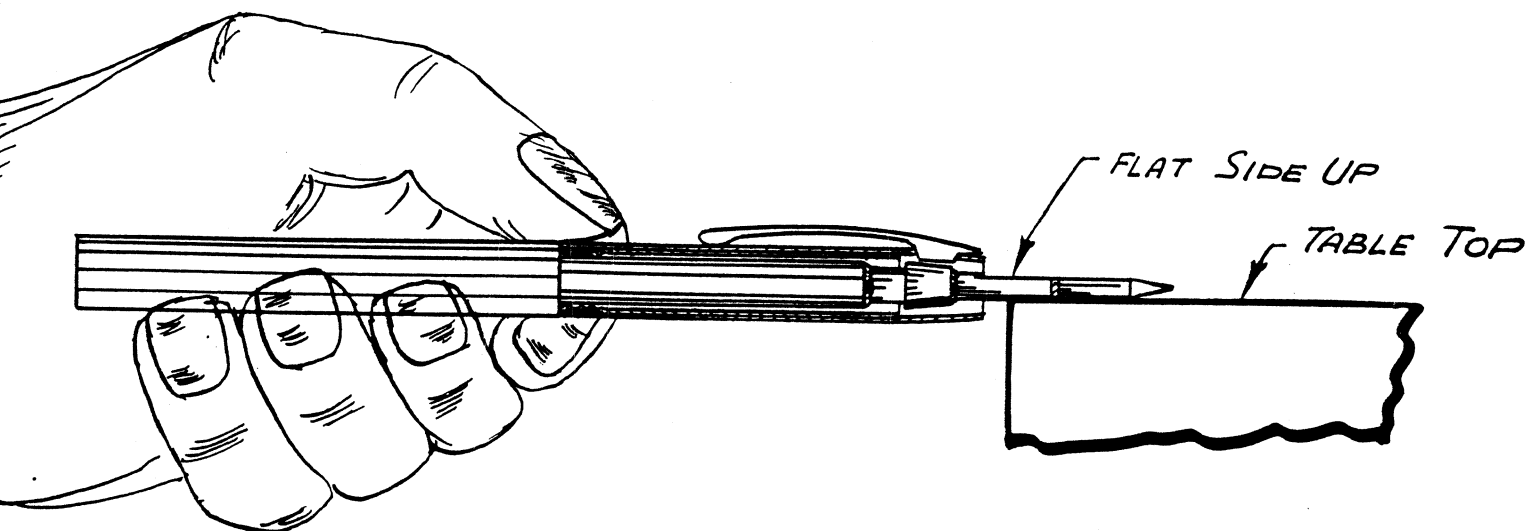

4. Tap the clip over the ears sharply with a plastic hammer (#75) so that the anvil area will cause the clip ears to clinch.
5. Remove arbor and assemble retracting mechanism with assembly tool (#25) modified as described on page C14.

**SIZE BARREL MOUTH:**

When a pen has been dropped causing the mouth to distort so the unit will not extend through, the mouth can be opened to the correct size by inserting the pointed arbor into the barrel and forcing it through the mouth.

## PART EXCHANGE POLICY

This policy is to be used only for the sole purpose of adjusting parts stocks to be used on repairs. The company reserves the right to refuse to handle shipments not judged to be in this category.

1. Any used lifetime cap can be exchanged for any other available cap on a dollar-for-dollar value basis for the lifetime exchange charge.\*
2. Any used lifetime point can be exchanged for any other available point on a dollar-for-dollar value basis for the lifetime exchange charge.\*
3. Any used lifetime barrel can be exchanged for any other available barrel on a dollar-for-dollar value basis for the lifetime exchange charge.\*
4. Any other used lifetime small part can be exchanged for any other available comparable small part on a dollar-for-dollar basis for the exchange charge.\*
5. Any used non-lifetime point can be exchanged for any other available non-lifetime point on a dollar-for-dollar basis for the non-lifetime exchange charge.\*
6. Any used non-lifetime barrel can be exchanged for any other available non-lifetime barrel on a dollar-for-dollar basis for the non-lifetime exchange charge.\*
7. Any used non-lifetime small part can be exchanged for any other non-lifetime available comparable small part on a dollar-for-dollar basis for the exchange charge.\*
8. Any used non-lifetime all metal or 1/4 Kt. trimmed pen or pencil cap will be exchanged for the used cap exchange charge. Other non-lifetime used pen, pencil, or ballpoint caps have no exchange value. Any new non-lifetime caps, plastic or metal, pen, pencil, or ballpoint, can be exchanged for any other available non-lifetime cap on a dollar-for-dollar basis. The charge for exchange will be 35¢ on Craftsman and Admiral pens - 40¢ on all other pens and 25¢ on pencils and ballpoint caps. Any cap with scars, mars, scratches, dents, or ink stains will be considered used.
9. This policy does not apply to 1/4 Kt. Masterpiece pen, pencil, or ballpoint caps and barrels.

\* We will supply in dollar value an equal amount of parts in exchange for the same value of used parts. When there is a difference in value, the part returned is of greater value than the part desired, an additional part must be supplied with the additional charge being billed at net. No credit will be issued. (See example sheet attached)

By using this new policy you can control your over-stock and understock condition by always requesting in exchange for over-stock parts, that we return parts on which you are under-stocked. Any over-stock condition should work itself out in due time in this manner. However, if you find it necessary to return new parts, not being able to adjust your stock by returning used parts, the same exchange charges (used parts exchange charges on attached sheet) will apply.

Attached is a copy of our exchange charges and an example sheet showing you how the new policy can be used and how charges will be figured. We believe this addition to our present policy will be mutually advantageous.

W. A. SHEAFFER PEN COMPANY

PARTS RETURNED

PARTS WANTED IN EXCHANGE

METHOD OF COMPUTATION

COST SERVICE CHARGE & NET BILLING

6 old style #8 lever barrels

Snorkel barrels

6 #8 bbls. @ \$2.60 = \$15.60 list  
 6 Snorkel bbls @ \$3.00 = \$18.00 list  
 Bill . . . . . 2.40 list

Service charge on 6 lifetime barrels @ .05 = .30 net  
 Billing for difference on extra barrel - \$2.40 list or \$1.20 net  
 Total for exchange, \$1.50 net

24 assorted - 93 Lifetime & 92 Lifetime points

12 Snorkel points

24 assorted #93 & 92 Lft. points @ \$6.00 = \$144.00 list  
 21 #12 Snorkel pts. @ \$7.00 = \$147.00 list  
 Bill . . . . . 3.00 list

Service charge on 24 lifetime points @ 10¢ each = \$2.40 net  
 Billing for difference on pt \$3.00 list or \$1.50 net  
 Total for exchange, \$3.90 net

18 assorted plungers

TM Plunger & Protector Tubes

18 Plungers @ .60 = \$10.80 list  
 27 TM Plunger & Protector Tubes @ .40 = \$10.80 list

Service charge on 18 plungers @ 10¢ ea. = \$1.80 net

4 Assorted #12 TM barrels

Craftsman barrels

4 TM bbls. @ \$2.60 = \$10.40 list  
 9 Craftsman bbls. @ \$1.25 = 11.25 list  
 Bill . . . . . .85 list

Service charge on 4 #12 TM bbls. @ .40 = \$1.60 net  
 Billing for difference on extra bbl. - 85¢ list or 42¢ net  
 Total for exchange, \$2.02 net

CONSOLIDATED PARTS EXCHANGE PRICES

These sheets condense all Parts Exchange Prices for your convenience. Prices apply to used parts accumulated from repair work and to new parts returned to adjust parts stocks in accordance with Parts Exchange Policy explained on Page D9, D10 and D11.

Net Exchange Price

PEN PARTS, MODELS WITH LIFETIME POINTS:

Point or Point Units	.10	Cap	.10	Assembled Barrels	.05
----------------------	-----	-----	-----	-------------------	-----

PEN PARTS, MODELS WITHOUT LIFETIME POINTS INCLUDING CURRENT LINES:

Points, Conv.:		Caps, Pre-Snorkel & Snorkel:		Assembled Barrels:	
Stainless Steel	No Exchange	Sovereign	1.55	Cadet, Craftsman, Admiral &	
#23, 3, 33	.35	Sentinel-Clipper	2.10	Cartridge (except Compact)	.05
#5, 52, 5SK, 6SK	.40	Crest-Triumph	2.45	Pre-Snorkel & Snorkel:	
#73, 74, 74SK	.45	Signature	3.35	Plastic	.40
#8	.50	Autograph	5.05	Gold Filled	2.45
Points, Sheath:		Snorkel Autograph (new)	3.60	14Kt Gold	13.20
C8W, C9W	.60	Masterpiece-Crest Masterpiece	13.20		

Other Caps:

Point Units:		Other Barrels:	
Stainless Steel	No Exchange	Lady Sheaffer I - XVII	1.00
Sheath Type, 14Kt Gold		Lady Sheaffer XX-XXI	2.00
and Palladium Silver	.75	Lady Sheaffer XXIII-XXIV	2.50
		Lady Sheaffer XXXV	4.00
Points & Gripping Sections:		PFM I, II, III	4.75
#14PFM, 15PFM	.60	PFM IV, V, Autograph	2.00
AS17, ASD17, AC21, ACD21,		Imperial III, IV, VI	2.10
AC20, & ACD20	.60	Compact I, II	2.45
		Imperial VI	4.00
Writing Units:		Imperial VI	2.10
#12 & 13SK	1.25	Other Used Caps:	No Exchange
#33, 52, 73, 74, 8, 10, 12 TD	1.00	New Caps Not Listed Above:	

Parts Related to Points:

Feeds	.10	Cadet, Craftsman, & Admiral	.35	CD, Black	.35
Feed Inserts	No Exchange	Other Models	.40	CD, Colored	.45
Filler Tubes & Inserts, 121SK	.30	Parts Related to Pen Caps:		55SD	.45
Filler Tubes & Inserts, 5SK, 74SK, 25	.05	Bands & Bands & Inner Caps	No Exchange	20FD, 92SD	.50
Filler Tube Inserts	No Exchange	Clips, Clip Sleeves & Springs	No Exchange	Snorkel	.40
Pierce Tubes	.10	Inner Cap & Inner Sleeve	No Exchange	Imperial	.90
Point Holders	.02	Plastic Cap Shells, PFM	.15	Compact	.60
Point Holder Gaskets	No Exchange	Other Cap Shells	No Exchange	Lady Sheaffer	1.75
Seal Gasket Washers	No Exchange				

Parts Related to Pen Barrels:

Barrel Shells, Plastic, Touchdown	.10
(with Plunger Knob)	
Barrel Shells Plastic, 202F,	
Snorkel PFM, Imperial (No	
Plunger Knob)	.10



CONSOLIDATED PARTS EXCHANGE PRICES CONT'D.

Parts Related to Pen Barrels Cont'd.	Net Exchange Price	PENCIL PARTS:	Net Exchange Price	BALLPOINT PARTS:	Net Exchange Price
Barrel Shells, Plastic, Imperial					
Desk Pen	.45	Pencils Matching Lifetime Pens:		Retractable Models:	
Compression Gasket ("0" Ring)	.02			Bands, Ballpoint	No Exchange
Friction Ring	No Exchange	Other Models:		Barrels, Plastic, Chrome,	
Gripping Section	.10	Bands, Pencil Cap	No Exchange	Tipped or Plain	.15
Gr. Sect. Compression Gasket	.02	Barrels, Plastic		Barrels, Plastic, Gold Tipped	.30
Gr. Sect. and Thread Rings	.20	Barrels, Gold Filled	.25	Barrels, All Metal, Anodized	.30
Levers	.10	Barrels, 14Kt.	2.15	Barrels, White Dot Stainless	
Lever Rings	No Exchange	Barrels, Lady Sheaffer I-XIV	9.00	Steel	1.15
Liners, Barrel	No Exchange	Barrels, Lady Sheaffer XV-XXI	.50	Barrels, White Dot Gold Filled	2.10
Plunger Knobs, Plastic	.05	Barrels, Lady Sheaffer XXXV	.75	Barrel Springs	No Exchange
Plunger Knobs, Gold Filled	.10	Clips, Pencil	.80	Barrel Tips	No Exchange
Plunger Knobs, 14Kt.	3.20	Clip Springs, Pencil	No Exchange	Cams	No Exchange
Plunger Knob Liners	No Exchange	Mechanisms	.30	Cap Shells	No Exchange
Plunger Knob Ornaments, PFM	.10	Mechanisms, CFL		Clips, Ballpoint	No Exchange
Plunger Rods & Washers	.10	Plastic Cap Shells, PFM, Imperial	.15	Clip Springs, Ballpoint	No Exchange
Plunger Tubes, Snorkel	.15	Quills, Desk Pencil	.15	Inner Sleeves	No Exchange
Plunger Tubes, TD, PFM, Imperial	.10	All Other Cap Shells	No Exchange	Mechanisms, Slide Collar	.15
Plunger Tube Gaskets	No Exchange	Tips	.20	Mechanism Sliding Spring	No Exchange
Plunger Tube Screws	No Exchange	Tips, 14Kt	No Exchange	Push Buttons, Slide Col. Mech	No Exchange
Propelling Springs	.05	Pencil Cap:		PushRods, Slide Spring Mech.	No Exchange
Pressure Bars	.05	Sovereign	.90	Thread Sleeves, Cap or Barrel	No Exchange
Quills, Touchdown	.10	Clipper & Sentinel	1.50		
Quills, 20FD, Snorkel, Imperial	.15	Crest & Triumph	2.15	Ballpoint Caps:	
Reinforcing Bands	No Exchange	Signature	2.60	Crest	2.00
Sacs	.03	Autograph	4.50	Signature	3.00
Sac Protector Assembly, Snorkel	.20	Autograph TP (New)	2.85	White Dot Stainless Steel	1.15
Sac Protector Assembly, PFM	.25	Masterpiece	9.00	White Dot Gold Filled	2.25
Sac Protector Bushings	.05	Lady Sheaffer I - XIV	.50		
Sac Protector Tubes	.10	Lady Sheaffer XV-XXI	1.00	Desk Ballpoint Pen Models:	
Threaded Bushings, PFM, Imperial IV,		Lady Sheaffer XXXV	1.10	Barrels & Quill S4TD	1.25
VI, Desk Pen, Compact I, II, Desk Pen	.10	PFM IV	1.50	Gripping Sections S4TD	.75
Threaded Bushings-Other Than		PFM V	2.15	Quills, DSL95, Black-	.20 Colored-
Above	No Exchange	PFM Autograph	2.85	Gripping Sect. DSL95, Black	.20
Thread Rings	.10	Other Used Caps:	No Exchange	Colored	.30
Vac Fill Cartridges-less Thread	.30	New Caps Not Listed Above:	.25		
Ring				Other Used Caps:	No Exchange
				New Caps Not Listed Above:	.25

## SUBSTITUTION POLICY

This policy is provided so you can identify the models on the Factory Substitution List. It should be used when obsolete models are brought into your shop. It not only identifies models on the Substitution List but also specifies which model should be made up and the price.

Substitutions are necessary for many reasons. In most cases the materials from which older repair parts are made are no longer available. There has been a great swing to molded parts in recent years, not only in the pen industry but in general, consequently, our suppliers no longer make flat, rod or tube stock. In fact, some of the suppliers are no longer in business.

To further complicate this problem, the plastic materials, the very best available at the time, tend to become brittle with age and shrink and fade. To correctly recondition a pen it must be dismantled and, during the process, even with the greatest of care, the brittle or shrunken parts may break. When we must replace a part, the parts will not fit or work well together due to shrinkage and will not match other parts due to fading.

To meet these problems we inaugurated our Substitution Program. This program is specifically designed so as to be to the advantage of the customer. We offer very generous trade in allowances, as high as 70% of the original price, on models 10, 20, 30 years old or older. If, for some reasons of sentimental attachment, the customer does not want to take advantage of this startling offer we will repair the old pen if it is a guaranteed model. These substitution pens are all black to avoid color matching problems in the future.

These advantages should be pointed out:

1. The substitution pen is a brand new pen of equal, or more, value than the old pen.
2. It has the one stroke modern touchdown filler, sure grip inner spring clip, better fluid control and modern design.
3. It will closely match the size and shape of the old pen.
4. The point will be of the same style and the customer can choose the point grade.
5. We no longer make Lifetime pens, however, the new pen will be serviced at a very nominal fee.
6. We will also exchange the pencil.
7. If the customer does not accept the offer we will repair the old one if it is a guaranteed model.

As a repair station you have these advantages:

1. The substitution pen is pre-snorkel. You will want to try to interest your customer in a new snorkel first.
2. You can make the substitution in your own shop for the prices shown on pages D18 and D19. The old pen should be dismantled and identified and sent in for parts exchange. These parts will be exchanged for the low exchange prices. As an example, in the case of a substitution on the Lifetime 93WH you receive \$3.50 from your customer and receive back replacement parts for only 25¢.

Remember, this program is definitely to your advantage. It is also definitely to the customers advantage and made available by us at such tempting prices only as a reward for our customers loyalty and because of our desire to provide good service, at any expense. Please cooperate and use the program as it is intended.

## HOW TO USE THIS LIST

### For Lifetime Models Only:

1. Determine if the pen is on the Substitution List. Outline drawings are provided on pages D16 and D17 to help identify all models on the Substitution List.
2. Using the number at the left, find the group the number is in on page D18. This page will change from time to time.
3. From the columns at the right determine the substitution model and price.
4. Inform your customer of the substitution offer using the sales outline on page D14.
5. If the customer accepts, make up the model with the correct parts. Don't forget to ask customer what grade of point he wants in the new pen.
6. Dismantle old parts and send in together for exchange. Identify the parts and we will exchange them for parts to make up the substitution model to replenish your stock. This will be done for the parts exchange charge.

### For Non-Lifetime Models (#3-#23-#33-#5-#55 points)

The following models are substituted in all colors: Models and Prices on Page D19.

All flat end models (made prior to 1930)

All mottled and black balance models (made prior to 1930)

All striated and black models with solid or visulated gripping sections that are not chased (made prior to 1945)

The following models are repaired:

All striated and black models with visulated gripping sections that are chased.

All Touchdown Models - All Snorkel Models.

All Tip-Dip Models - All Skripsert Models.

---

### COLOR CODE EXPLANATION

- L - Black
- A - Black and gray mottled with lines of red.
- K - Green and white mottled.
- H - Green and black mottled.
- J - Green and white mottled.
- D - Black and pearl mottled with red and green highlights in pearl.
- C - Brown and black striped.
- E - Green and black striped.
- F - Rose and black striped.
- P - Gray and black striped.
- S - Carmine and black striped.

---

Pencil Substitution List on page D19.

Pencil must be traded in to qualify for substitution price.

WHITE DOT MODELS

Plastic Cap - #73 Points

- 1. 73V - Lever fill.
- 2. 73WS - Vac fill.

- 3. 73H - Lever fill.
- 4. 73WH - Vac fill.

- 5. 73T - Lever fill.
- 6. 73W - Vac fill.

- 7. 735WS - Same size as 73WS - Vac fill - Autograph band.
- 8. 735V - Same size as 73V - Lever fill - Autograph band.

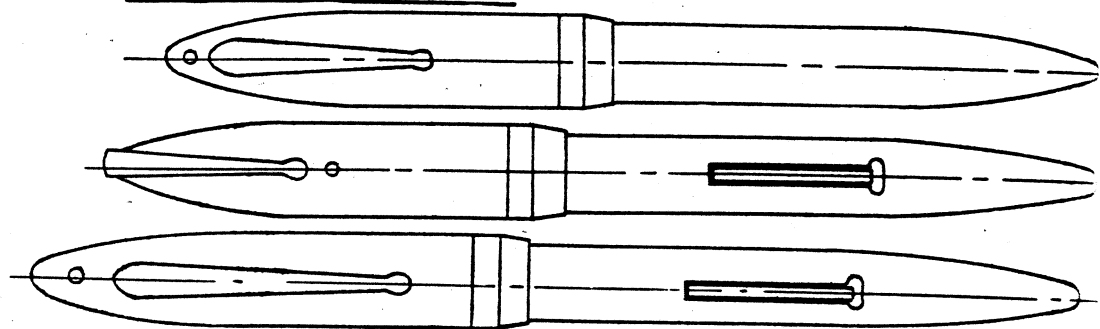

Plastic Cap - #74 Points

- 9. 74SC - Lever fill.

- 10. 74SR - Lever fill - Ring in cap - No clip.

- 11. 74AC - Same size as 74SC with balance cap and flat end barrel.
- 12. 74AR - Same size as 74SR with balance cap with ring and flat end barrel.
- 13. 743T - Same size as 73T - Lever fill.

- 14. 74T - Lever fill.

- 15. 74W - Vac fill.

- 16. 74TR - Same size as 74T ring in cap - no clip - Lever fill.
- 17. 74TCD - Same as 74T with quill on end of barrel - Lever fill.
- 18. 74P - Same as 74T with pencil on barrel - Lever fill.

- 19. 74H - Lever fill.

- 20. 74WH - Vac fill.

- 21. 74V - Lever fill.

- 22. 74VR - Lever fill - Ring in cap - No clip.

- 23. 74MC - Smaller than 73V - Lever fill.
- 24. 74MR - Smaller than 73V - Ring in cap - Lever fill.
- 25. 75T - 76T - Same size as 74T - Lever fill - Autograph band.
- 26. 75W - 76W - Same size as 74W - Vac fill - Autograph band.

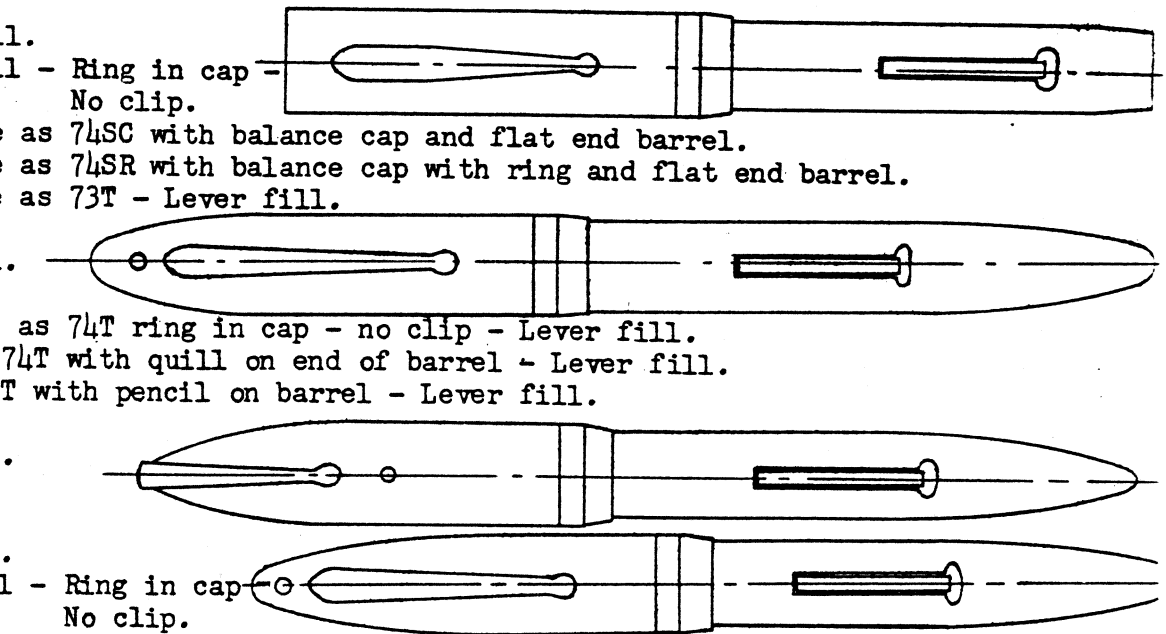

Plastic Cap - #8 Points

- 27. 8T - Lever fill.

- 28. 8W - Vac fill.

- 29. 8TR - Same size as 8T - Ring in cap - No clip - Lever fill.

- 30. 8C - Lever fill.

- 31. T8C - Same length as 8C - Flat end - Smaller diameter - Lever fill.
- 32. 8AC - Same size as 8C - with balance cap and flat end barrel - Lever fill.
- 33. 8AR - Same size as 8C - with balance cap with ring and flat end barrel - Lever fill.
- 34. T8SC - Same size as 74SC - flat end - Lever fill.
- 35. T8SR - Same size as 74SC - Flat end - Ring in cap - Lever fill.
- 36. T89C - 89C - 85C - T85C - Same length as 8C - Flat end - Varying diameters - Autograph bands - Lever fill.
- 37. T85SC - Same size as 74SC - Autograph band - Lever fill.
- 38. 85T - 86T - Same size as 8T - Autograph band - Lever fill.
- 39. 85W - Same size as 8T - Autograph band - Vac fill.

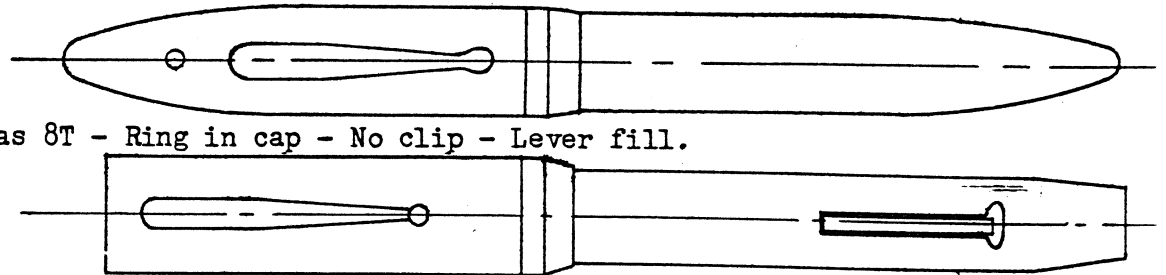

WHITE DOT MODELS

Plastic Cap - Sheath Points

40. 93H - Lever fill.

41. 93WH - Vac fill.

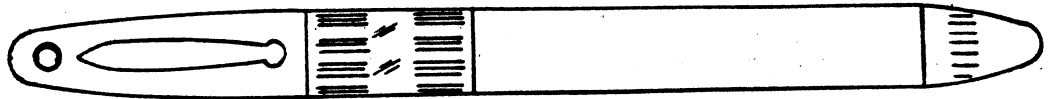

42. 93WM - Vac fill.



43. 93H Auto - Same size as 93H - Autograph band.

44. 93WH Auto - Same size as 93WH - Autograph band.

45. 93WM Auto - Same size as 93WM - Autograph band.

Metal Cap - #73 Points

46. 46A - Gold filled cap and barrel -  
Lever fill.

47. 46AW - Gold filled cap and barrel -  
Vac fill.

48. 446A - Same size as 46A - 14 Kt. gold cap and barrel - Lever fill.

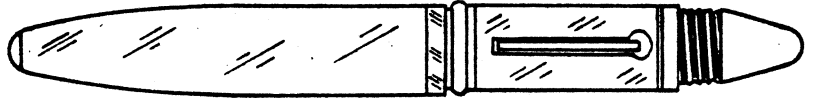

49. 26V - Gold filled cap -  
Lever fill.

50. 26WS - Gold filled cap -  
Vac fill.

51. 266V - Same size as 26V - 14 Kt. gold cap - Lever fill.

52. 7336TC - Same size as 47T - 14 Kt. gold cap and barrel - Lever fill.

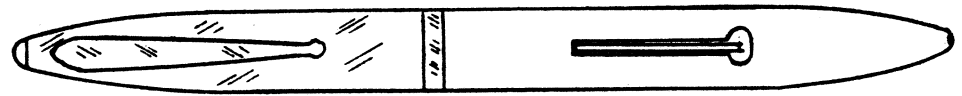

Metal Cap - #74 Points

53. 47T - Gold filled cap -  
Lever fill.

54. 47W - Gold filled cap -  
Vac fill.

55. 476T - Same size as 47T - 14 Kt. gold cap - Lever fill.

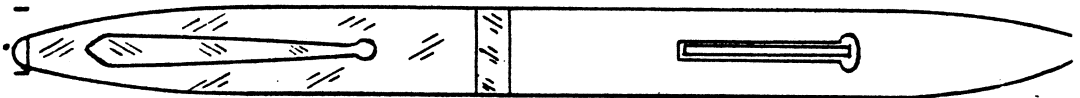

Metal Cap - Sheath Points

56. 49T - Gold filled cap -  
Lever fill.

57. 49W - Gold filled cap -  
Vac fill.

58. 49WM - Gold filled cap -  
Vac fill.

59. 497W - Same size as 49T - 14 Kt. gold cap - Vac fill.

60. 9337T - Same size as 49T - 14 Kt. gold cap and barrel.

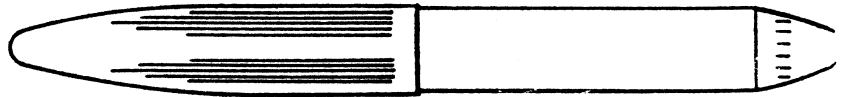

Desk Pens and Sockets - #74 Points

61. 74D - 74DP - 74DG - Lever Fill. Socket and Post also substituted to match pen.

Desk Pens and Sockets - Sheath Points

62. C92WD - Vac Fill. Socket and Post also substituted to match pen.

WHITE DCT MODELS

Key	Symbol No.	Substitution Model:			Price	Key No.	Symbol No.	Substitution Model:			Price
		Cap	Barrel	Nib				Cap	Barrel	Nib	
1	73V					43	93				
2	73WS					44	93WH Auto	121S	121S	121S	\$6.50##
3	73H	121S	121S*	73SH	\$3.00#	45	93WM Auto	Auto			
4	73WH					46	46A	37WM	82SM*	73SH	3.50##
5	73T					47	47AW				
6	73W										
7	735WS					48	This substitution made at factory only			10.00##	
8	735V	121S-6	121S*	73SH	4.50##						
9	74SC					49	26V				
10	74SR					50	26WS	112S	112S*	73SH	3.50##
11	74AC										
12	74AR					51	This substitution made at factory only			10.00##	
13	74ST										
14	74T					52	This substitution made at factory only			15.00##	
15	74W										
16	74TR	121S	121S**	74SH	3.00#	53	47T	112S	121S**	74SH	3.50##
17	74TCD					54	47W				
18	74P					55	This substitution made at factory only			10.00##	
19	74H										
20	74WH					56	49T	112S	121S	121S	5.00##
21	74V					57	49W				
22	74VR					58	49WM				
23	74MC										
24	74MR										
25	75T-76T	121S-6	121S**	74SH	4.50##	59	This substitution made at factory only			10.00##	
26	75W-76W										
27	8T					60	This substitution made at factory only			17.00##	
28	8W										
29	8TR	Choice of:				61	74D-74DP	79D Skt	92SD***	74SH	3.00#
30	8C										
31	T8C-84C	1) 920S	82S	8SH	3.00#	62	C92WD	79D Skt	92SD	92SH	3.50#
32	8AC	2) 8T	8T	8SH	3.00#						
33	8AR	-(For those who like the larger size.)									
34	T8SC										
35	T8SR										
36	T89C-89C	Choice of:									
37	T85SC	1) 920S	82S	8SH	6.50##						
38	85T-86T	Auto									
39	85W	2) 8T	8T	8SH	6.50##						
		Auto	(For those who like the larger size.)								
40	93WH										
41	93WH	121S	121S	121S	3.50#						
42	93WH										

\* Fitted with 73S barrel end.  
 \*\* Fitted with 74S barrel end.  
 \*\*\* Fitted with 55SD barrel end.  
 # Plus 10% Manufacturers Excise Tax (When exchanged at factory)  
 ## Plus 10% Federal Retailers Excise Tax

PENCILS MATCHING LIFETIME MODELS			
Price	Substitution Model	Cap	33S
		Barrel	33S
		Nib	
\$ 2.50#		Use customers point if ok, if not use #33	
3.00#		Use customers point if ok, if not use #52	
3.00#		Use customers point if ok, if not use #33 or 55SD section - 79D skt #52	
		55SD holder with 33SD or 55SD ok, if not use #33 or #52	
		All Desk Pens with #3 or #5 Points	
		All Pens with #22 - #23 - #3 - #33 Points	
		All Pens with #53 - #5.30 - #5 - #55 Points	
		Models	

PENCILS MATCHING SUBSTITUTED NON-LIFETIME MODELS			
Price	Substitution Model	Cap	LH40
		Barrel	LH40
		Mech	
\$ 1.50#		Balance	
3.00#		Balance	
4.50#		Balance	
7.50#		Balance	
2		LH40-6	
3		LH40-Auto	
4		LH6	
5		LH40	
6		LH40	
		Gold Filled - Plastic Barrel	
		All Plastic - LKt Signature Band	
		All Plastic - LKt Autograph Band	
		LKt Cap - Plastic Barrel	
		LKt Cap - Barrel	
		This substitution made at factory only	
		This substitution made at factory only	
		This substitution made at factory only	

Price	Substitution Model	Cap	H3
		Barrel	H3
		Mech	
2.50#		Balance	
2.75#		Balance	
		Models	
		Pencils to match pens with #22 - #23 - #3 - #33 Points	
		Pencils to match pens with #53 - #5.30 - #5 - #55 Points	

# Plus 10% Manufacturers Excise Tax. (When exchanged at factory)  
 # Plus 10% Federal Retailers Excise Tax.

3/1/60

## REPAIR INSTRUCTIONS

The list price of the C8W point has been reduced from \$2.75 to \$2.25. The exchange price remains at .60. Please make this correction on pages B45 and B51.

### SPECIAL TECHNICAL INFORMATION

The C8W point is now being made slightly thicker, therefore, the feed is being made thinner. Since this difference is not detectable to the eye, a special marking has been placed on both feeds and points as illustrated below. This change was made necessary by the manufacturing process only and the old points are still completely satisfactory for use on old or new pens as long as the correct feed is used. Conversely, the newer point will assemble with the older pens as long as the correct feed is used.

#### OLD STYLE FEED & POINT

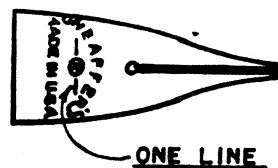
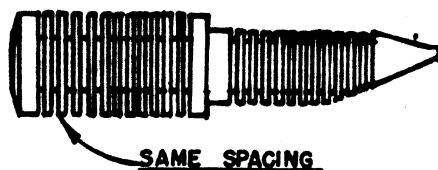



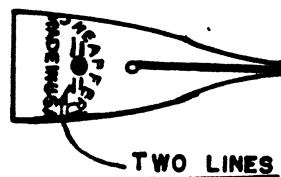
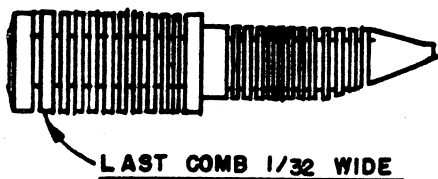













#### NEW STYLE FEED & POINT

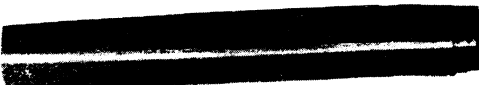



NOMENCLATURE OF SNORKEL PEN PARTS

-  - - - - - POINT
-  - - - - - TRIUMPH POINT UNIT
-  - - - - - FEED
-  - - - - - POINT HOLDER
-  - - - - - GRIPPING SECTION AND THREAD RING
-  - - - - - POINT HOLDER GASKET
-  - - - - - FILLER TUBE AND INSERT
-  - - - - - SAC PROTECTOR BUSHING
-  - - - - - SAC
-  - - - - - PROPELLING SPRING
-  - - - - - BARREL REINFORCING BAND
-  - - - - - BARREL SHELL
-  - - - - - COMPRESSION GASKET
-  - - - - - SCREW AND PLUNGER TUBE GASKET
-  - - - - - THREADED PLUNGER TUBE
-  - - - - - THREADED SAC PROTECTOR TUBE ASSEMBLY
-  - - - - - PLUNGER KNOB













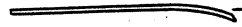







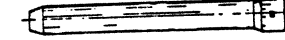

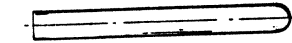
(See individual pen pages for part prices and part exchange prices.)

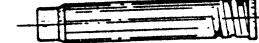
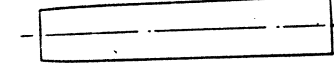
NOTE: Complete barrel assembly includes: Plunger Knob, Barrel Shell, Compression Gasket, Reinforcing Band, Screw, Plunger Tube Gasket and Threaded Plunger Tube.

Threaded Sac Protector Tubes sold only as an assembly which includes: Threaded Sac Protector Tube, Sac and Sac Protector Bushing.

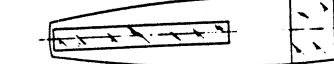
NOMENCLATURE OF PFM, IMPERIAL TOUCHDOWN & COMPACT PENS

PART CONTAINED IN MODELS

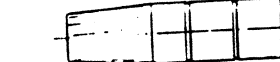
	POINT & GRIPPING SECTION	PFM IMPERIAL COMPACT
	FEED	PFM IMPERIAL COMPACT
	FEED INSERT OR FILLER TUBE & INSERT	PFM IMPERIAL COMPACT
	FILLER TUBE INSERT	PFM
	SEAL GASKET WASHER	PFM
	POINT HOLDER GASKET	PFM
	GRIPPING SECTION COMPRESSION GASKET	IMPERIAL COMPACT
	FRICITION RING	PFM IMPERIAL COMPACT
	THREADED BUSHING	PFM
	THREADED BUSHING	IMPERIAL COMPACT
	PIERCE TUBE	COMPACT
	SAC PROTECTOR ASSEMBLY	PFM
	SAC PROTECTOR TUBE	PFM IMPERIAL
	SAC PROTECTOR BUSHING	PFM
	SAC	PFM IMPERIAL
	PROPELLING SPRING	PFM
	PLUNGER TUBE	PFM IMPERIAL
	BARREL OR BARREL SHELL	PFM IMPERIAL COMPACT
	PLUNGER KNOB	PFM IMPERIAL
	BARREL COMPRESSION GASKET	PFM IMPERIAL
	PLUNGER TUBE GASKET	PFM IMPERIAL
	PLUNGER TUBE SCREW	PFM IMPERIAL
	CAP	PFM IMPERIAL COMPACT
	CLIP	PFM IMPERIAL COMPACT
	CLIP SPRING	PFM IMPERIAL COMPACT
	PLASTIC CAP BLANK	PLASTIC CAP MODELS ONLY
	BAND & INNER CAP	PLASTIC & METAL CAP WITH BAND
	INNER CAP	METAL CAPS WITHOUT BANDS